

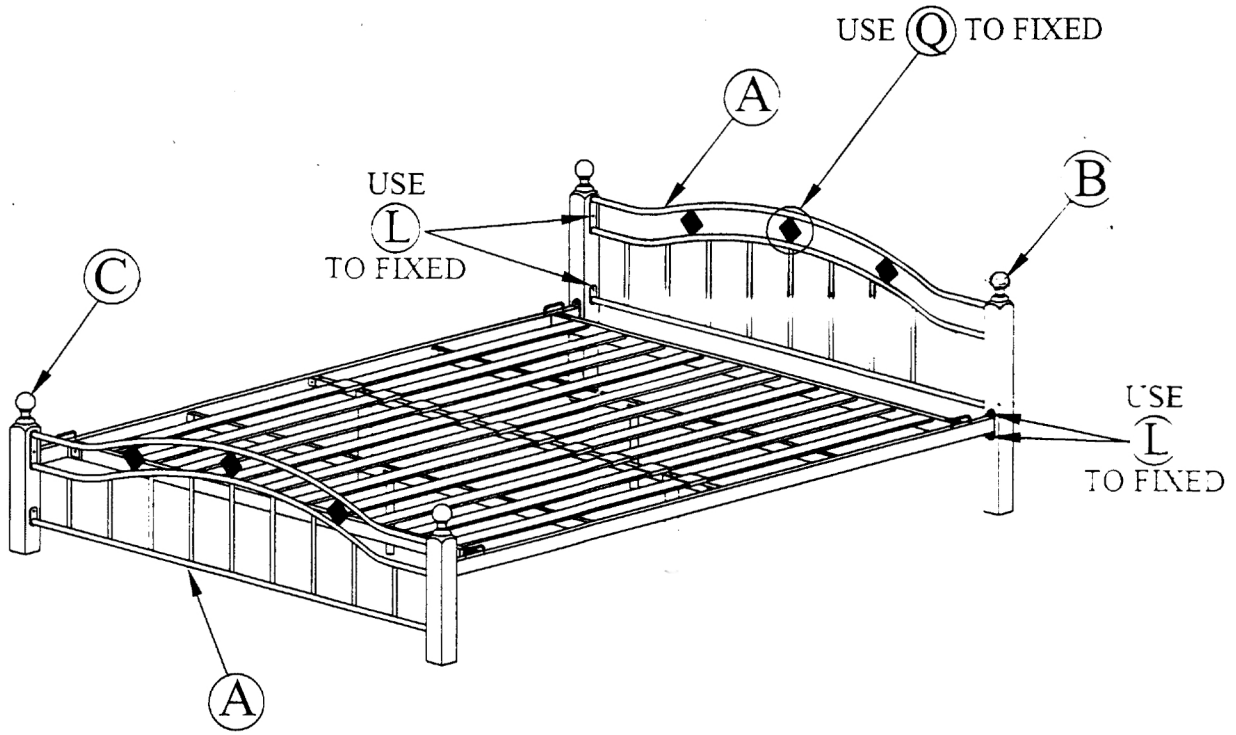

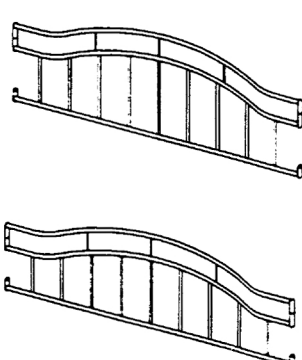

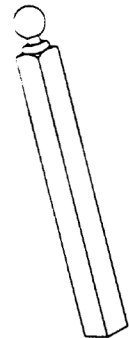





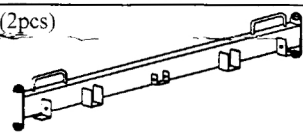
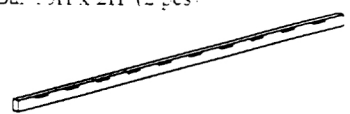
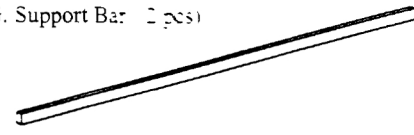
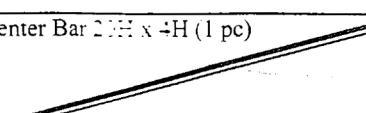



FLORENCE QUEEN BED



PART LIST

<p>A. Head Board (1pc) & Foot Board (1pc)</p> 	<p>B. Woodpost "H" (2pcs)</p> 	<p>C. Woodpost "L" (2pcs)</p> 	<p>E. Siderail (2pcs)</p>  <p>F. Center Bar 10H x 2H (2 pcs)</p>  <p>G. Support Bar (2 pcs)</p>  <p>Z. Center Bar 20H x 4H (1 pc)</p> 
		<p>D. Wooden Bed Slat (20 pcs)</p> 	<p>H. Short Legs (2pcs) I. Long Legs (2pcs)</p> 

HARDWARE LIST

K.		L Allen Key M4		1 pc
L.		M6 x 25mm Bolt	Head & Foot Board / Siderail	16 pcs
M.		M6 x 50mm Bolt	Support Bar with Short Legs	2 pcs
N.		M6 x 40mm Bolt	Center Bar 20H x 4H / Long Legs	4 pcs
O.		M6 x Hex Nut	M6 x 40mm Bolt	2 pcs
P.		Plastic Cap	Center Bar 20H x 4H	10 pcs
Q.		M3.5 x 12mm Screw	Wood Deco	12 pcs
R.		Wood Deco	Head & Foot Board	6 pcs
T.		M6 x 45mm Bolt	Bracket	4 pcs
U.		Bracket	Center Bar 10H x 2H	4 pcs