



ARCO

A

A - 965 mm / 1935 mm / 540 mm

2019-04-18

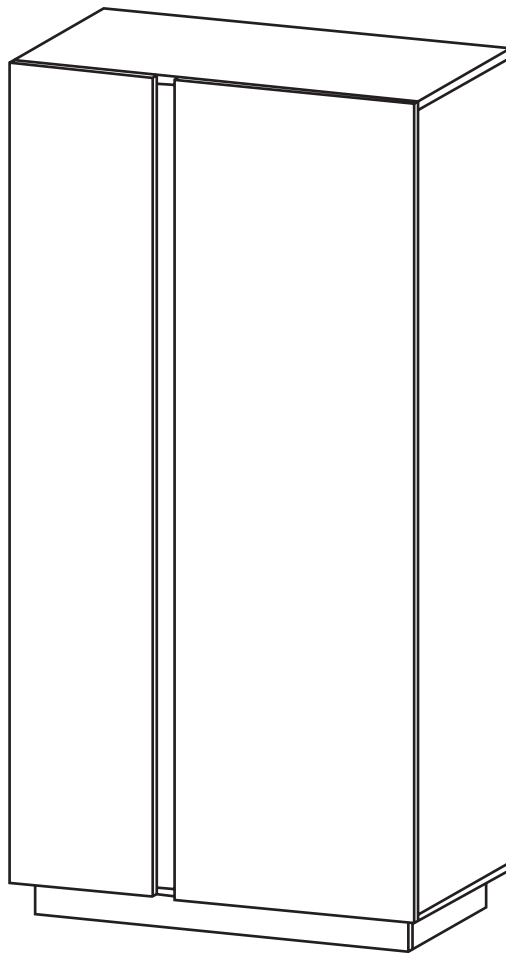



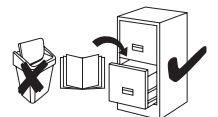
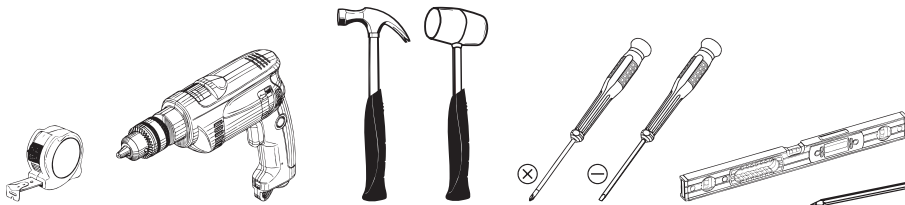



 180 min.

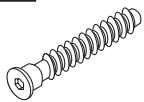
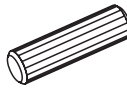
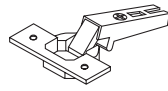
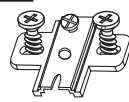
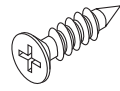
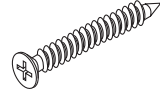

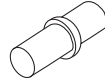
ARCO - A - 1

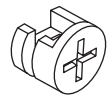
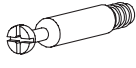
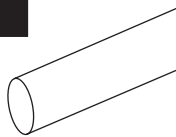
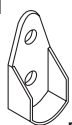
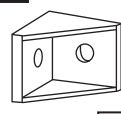
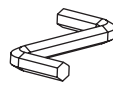
A:

A  7 x 50 mm x 6	B  8 x 32 mm x 34	C  (P) x 6	DT  x 6	E  3,5 x 13 mm x 18	E2  3 x 20 mm x 14
G2  x 5	H1  x 12	P  x 12	Q2  Ø 20 x 8	R  H=11 mm x 14	U  L=24,3 mm x 14
V  L=560 mm x 1	V7  x 2	W6  x 1	XA  x 1	XG  GLUE x 1	ZR  Ø 15 x 14

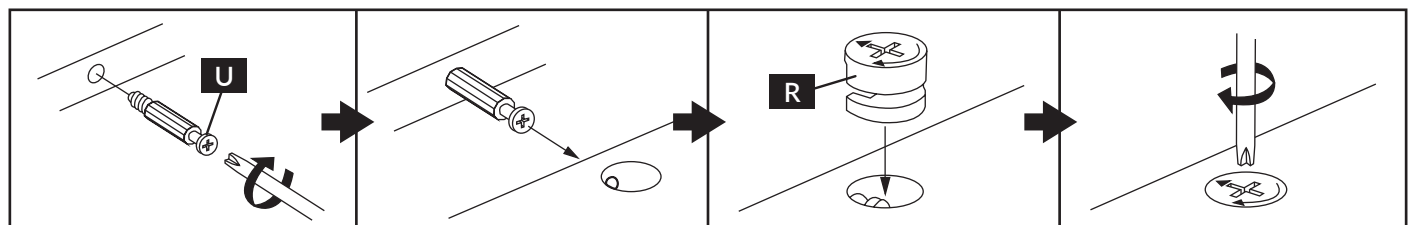
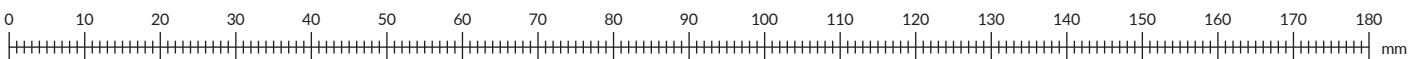
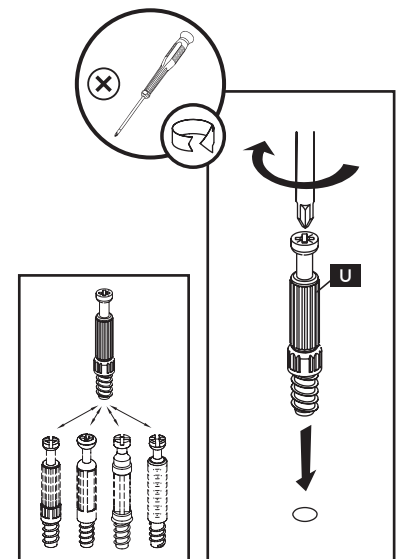

1	A-1	885 / 80 / 16 mm	x 1
2	A-2	424 / 80 / 16 mm	x 2
3	A-3	965 / 520 / 16 mm	x 1
4	A-4	348 / 478 / 16 mm	x 1
5	A-5	568 / 478 / 16 mm	x 1
6	A-6	348 / 478 / 16 mm	x 3
7	A-7	965 / 520 / 16 mm	x 1
8	A-8	1817 / 520 / 16 mm	x 1
9	A-9	1817 / 479 / 16 mm	x 1

10	A-10	1817 / 520 / 16 mm	x 1
11	A-11	1817 / 100 / 16 mm	x 1
12	A-12	338 / 1850 / 16 mm	x 1
13	A-13	566 / 1850 / 16 mm	x 1
14	A-14	1830 / 360 / 3 mm	x 1
15	A-15	1830 / 584 / 3 mm	x 1

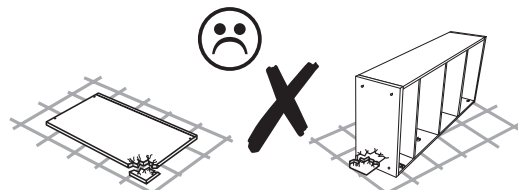
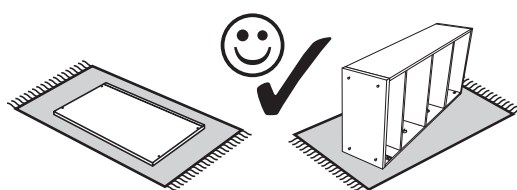
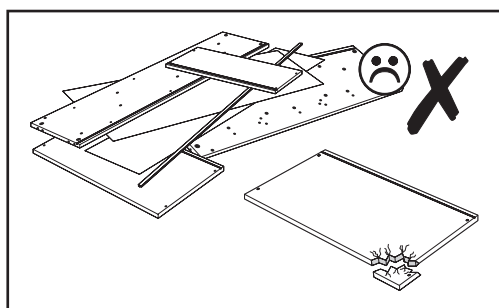
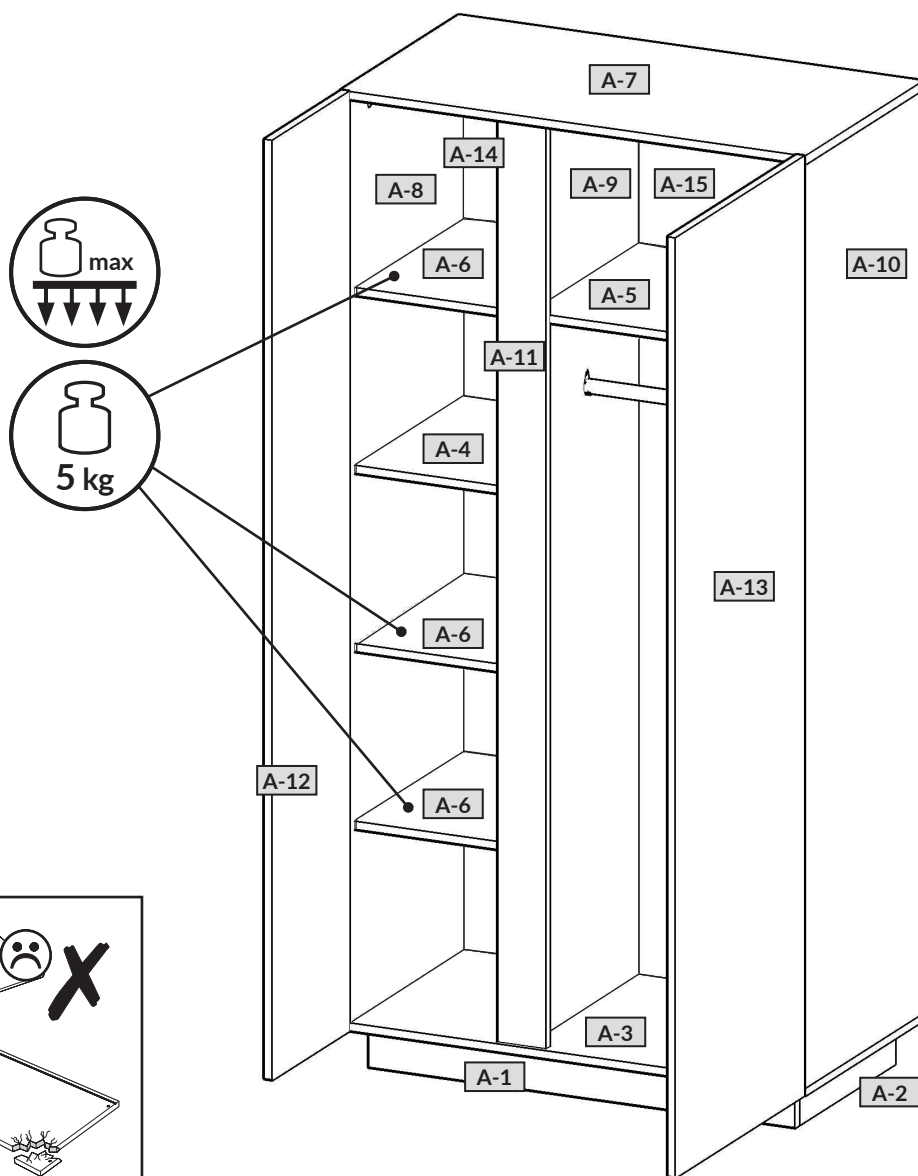

A / 1

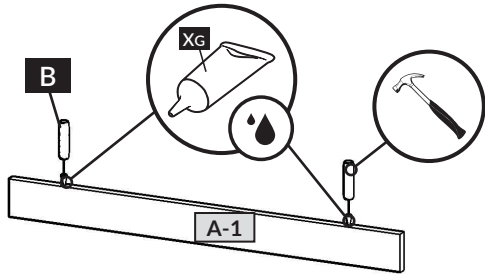

B	x 10
XG	x 1

2x →

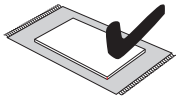
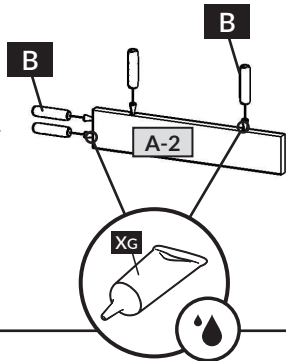

A / 2

XG x 1

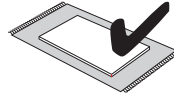
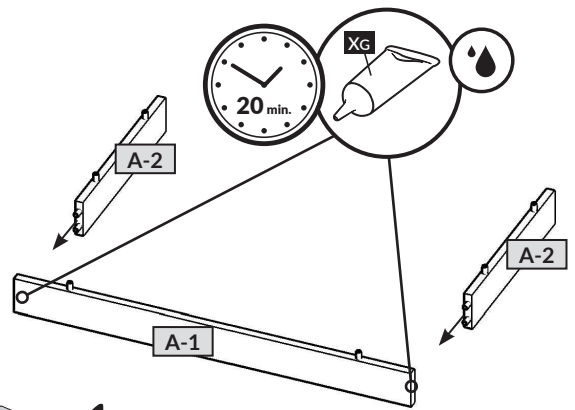

A / 3

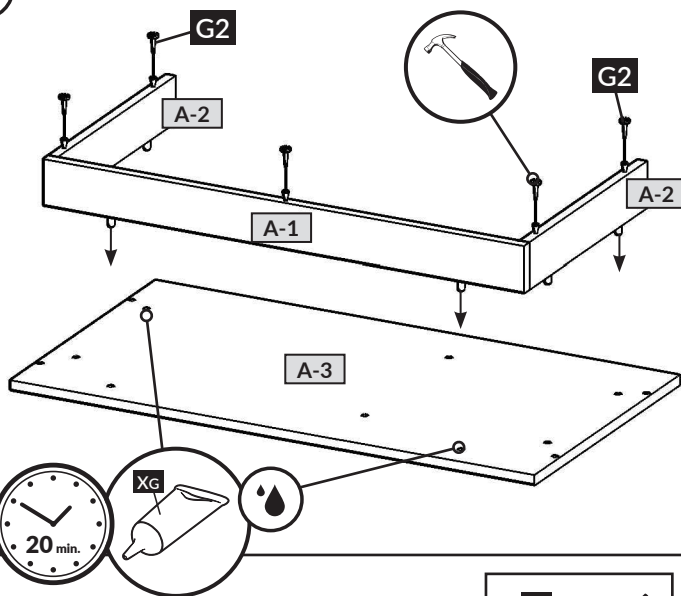
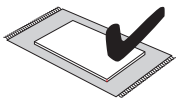

G2	x 5
XG	x 1

A / 4

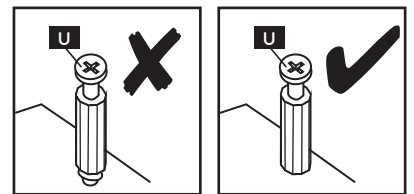
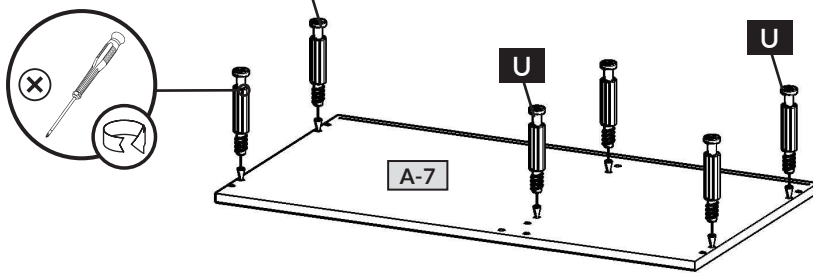

B	x 8
R	x 8
U	x 6

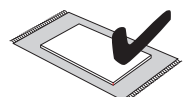
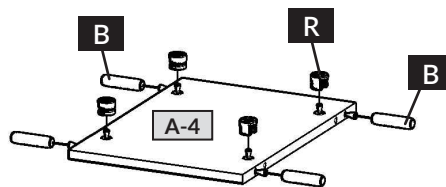
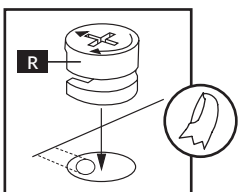
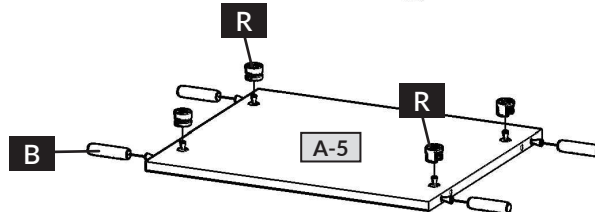

A/5

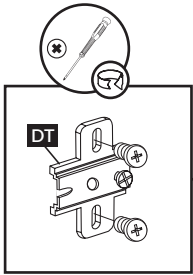
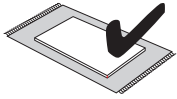

B	x 8
DT	x 3
P	x 12
R	x 2
U	x 4

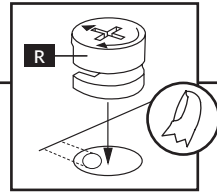
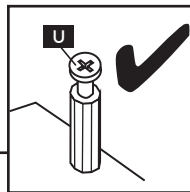
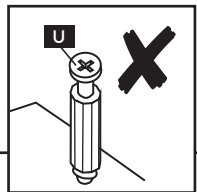
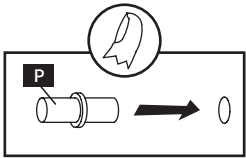
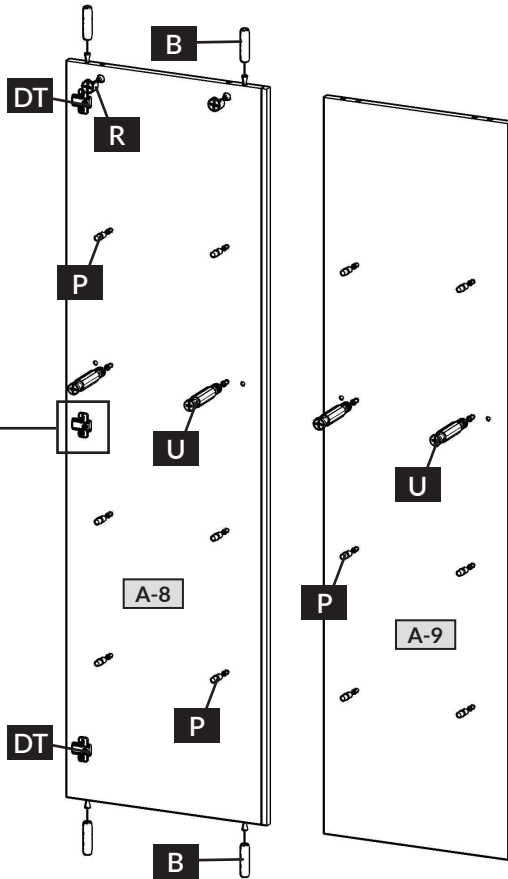

A/7

C	x 6
E	x 12

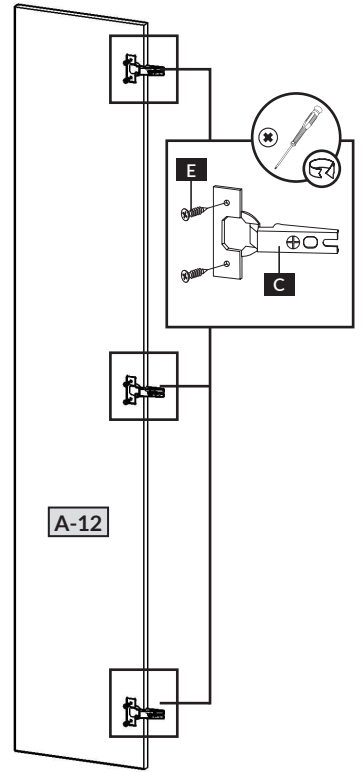

A/6

B	x 8
DT	x 3
E	x 4
R	x 4
U	x 4
V7	x 2

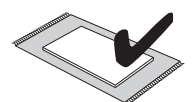
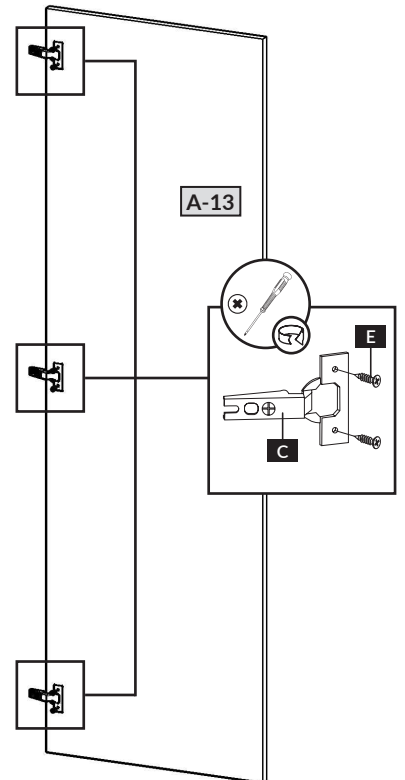
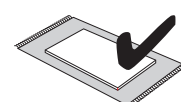
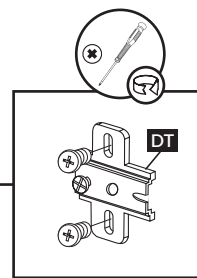
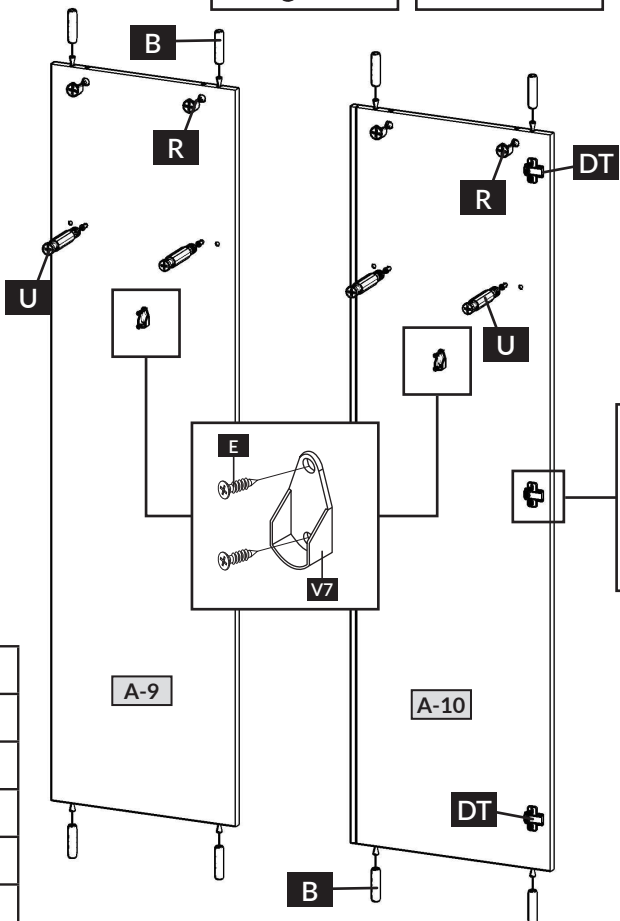

A / 8

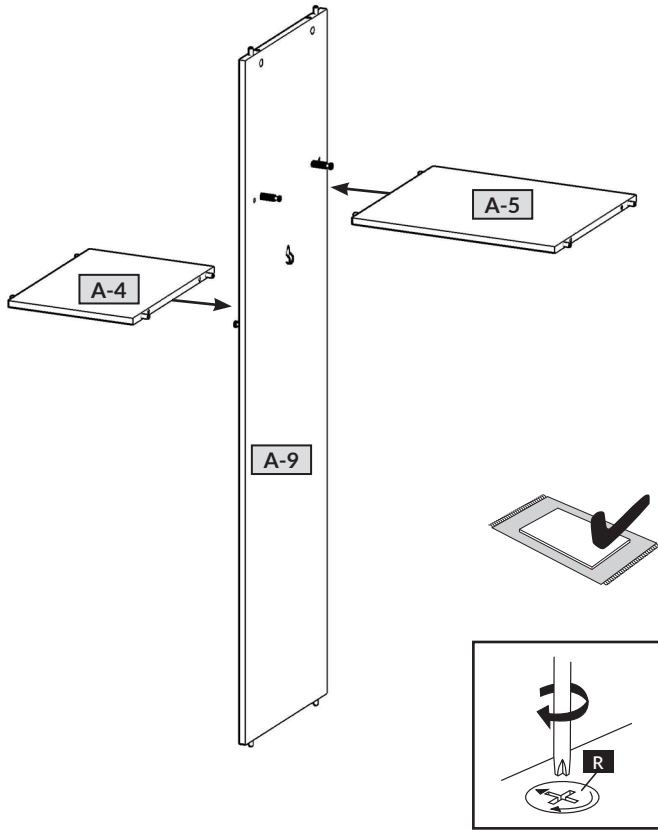

A / 9

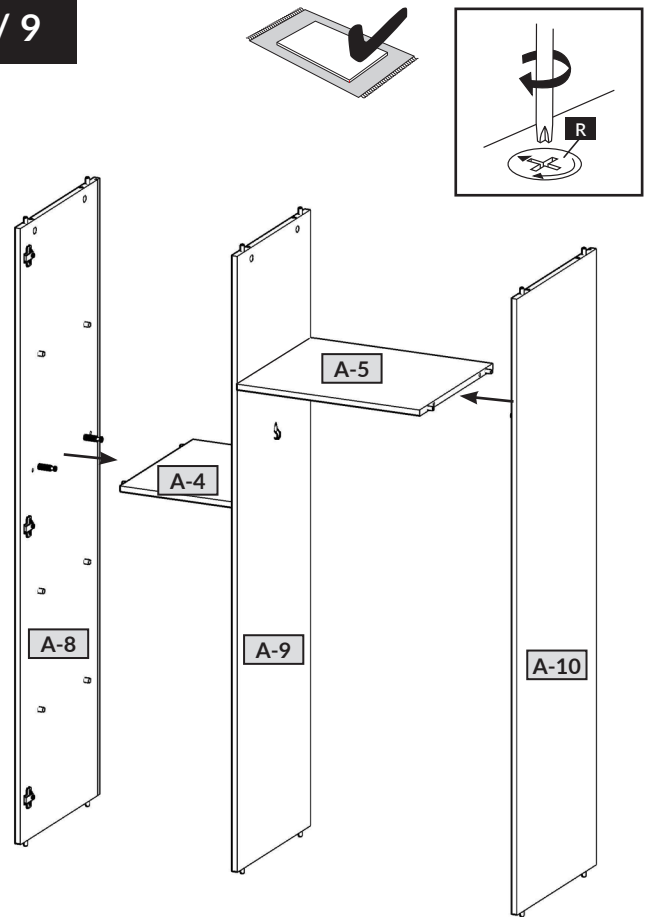

A / 10

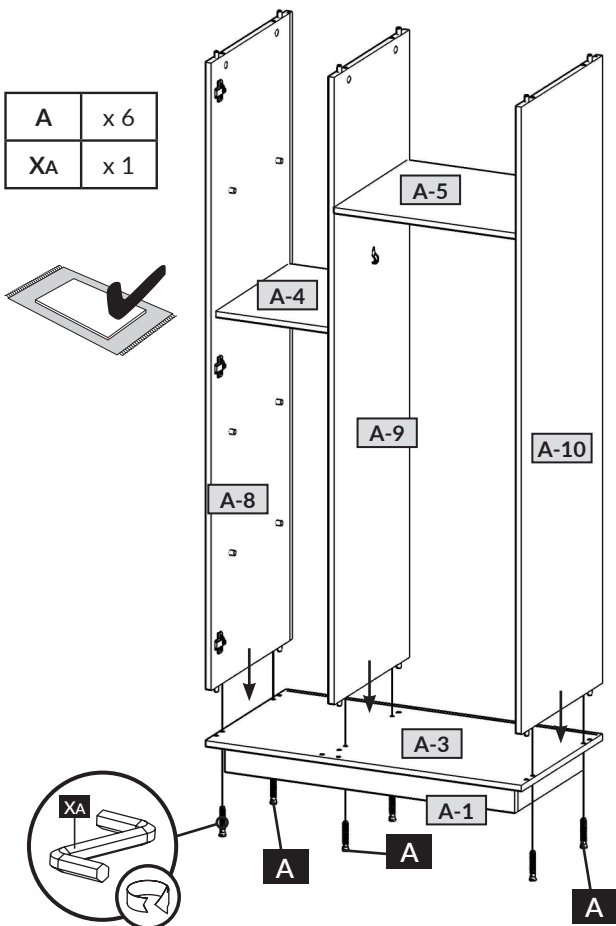

A / 11

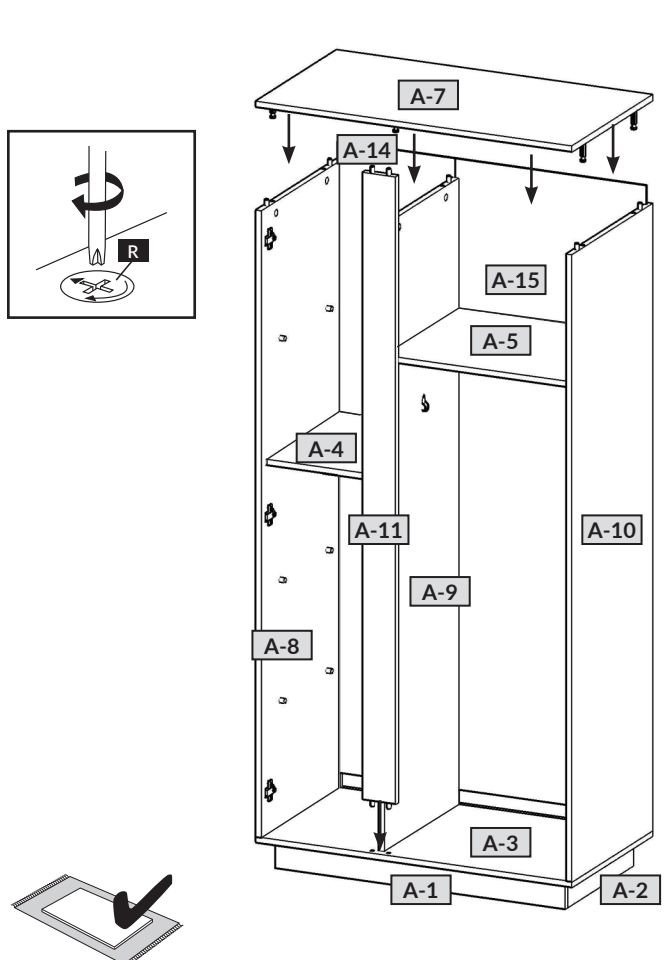

A / 12



E2	x 14
H1	x 12
Q2	x 8

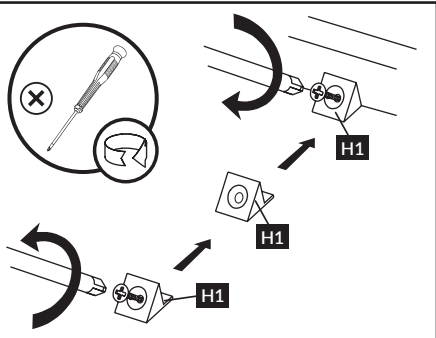
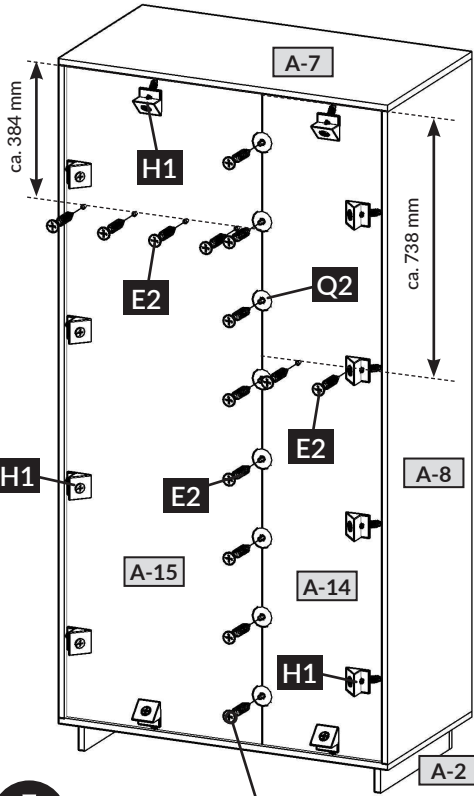
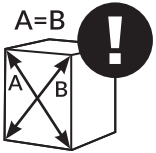

A / 14

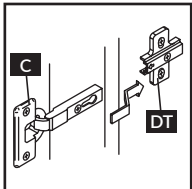

V	x 1
---	-----

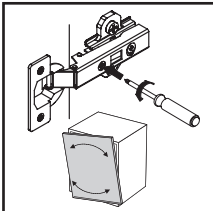
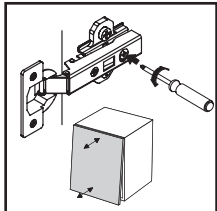
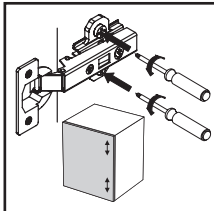

A / 13

E	x 2
W6	x 1
ZR	x 14

