











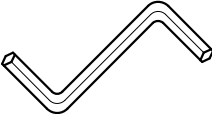
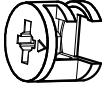
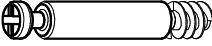

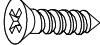
| | | | | |
|--|--|---|---|--|
|  Ø6,3x50 mm A1 x 40 |  Ø12 mm A2 x 36 |  4 mm A3 x 1 |  Ø15x12 mm B1 x 7 |  Ø5x44 mm B2 x 7 |
|  Ø20 mm B3 x 7 |  Ø3x16 mm D1 x 18 |  Ø4x16 mm D2 x 14 |  Ø4x30 mm D3 x 10 |  Ø4,2x32 mm D4 x 4 |
|  Ø1,6x25 mm F x 60 |  Ø8x36 mm G x 32 |  H x 2 |  K x 1 | |
|  Ø5x16 mm L x 4 |  M x 2 |  Ø15 mm N x 6 |  X x 2 |  V x 3 |
| | | | | |

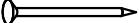

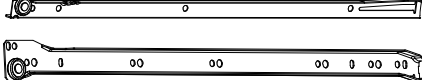
Box 1

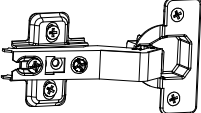
328x521x3 mm

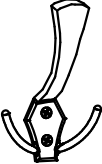
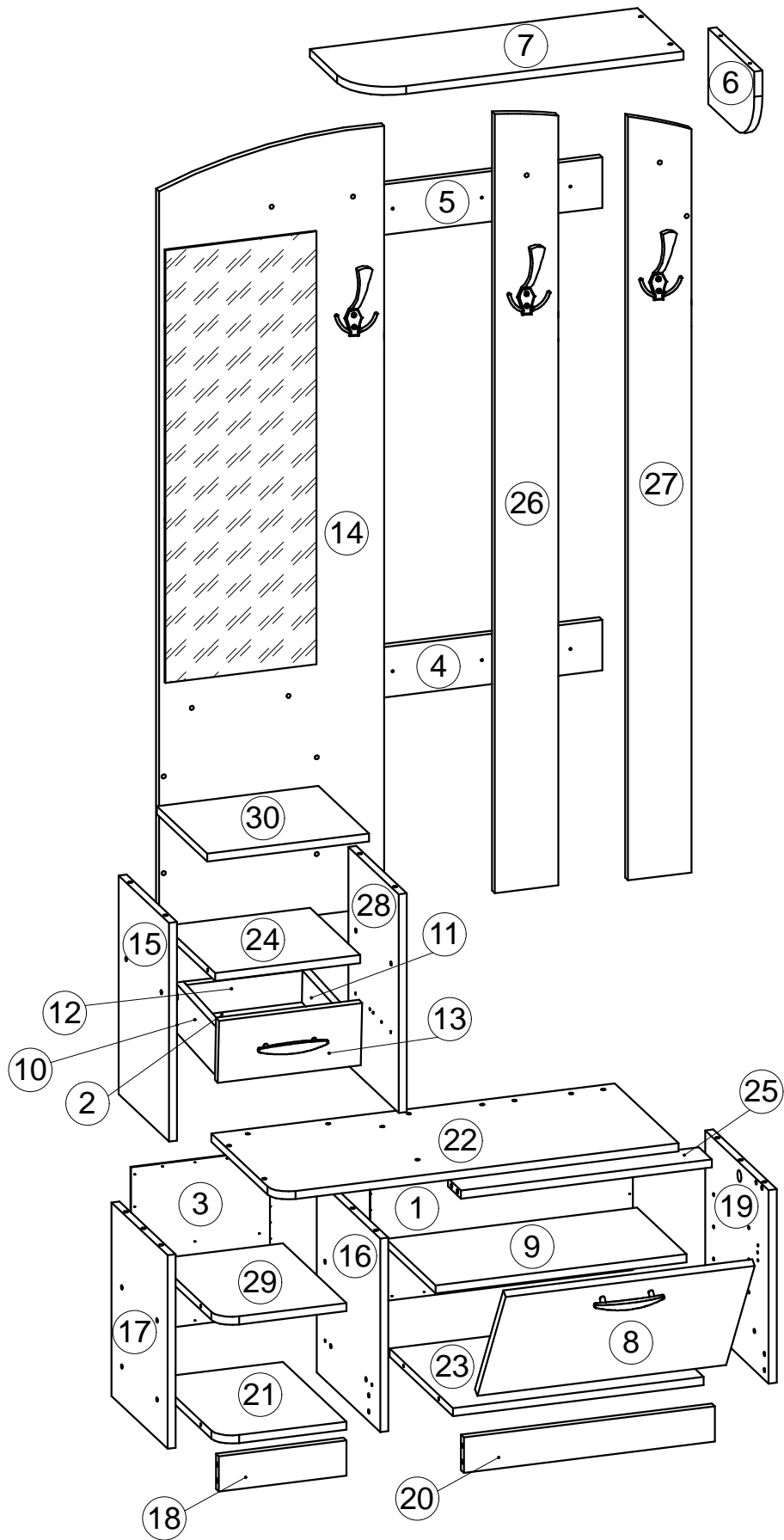
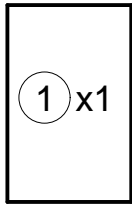

328x276x3 mm

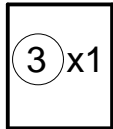

260x256x3 mm

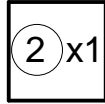

650x250x16 mm

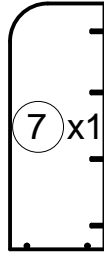

293x493x16 mm

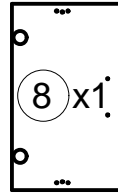

498x270x16 mm

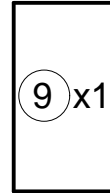

434x274x16 mm

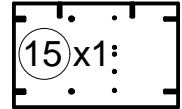

150x250x16 mm

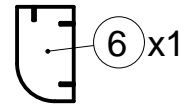

Fittings & Tools

384x346x16 mm

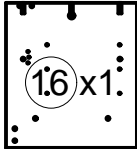

384x306x16 mm

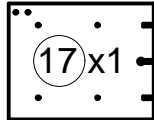

384x346x16 mm

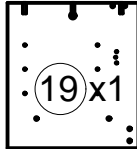

253x346x16 mm

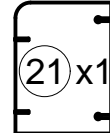

800x347x16 mm

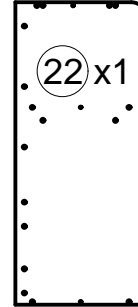

498x345x16 mm

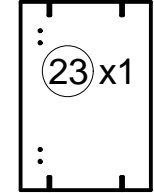

288x273x16 mm

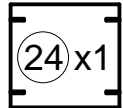

434x274x16 mm

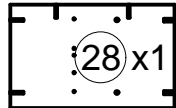

253x346x16 mm

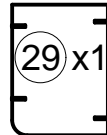

320x275x16 mm

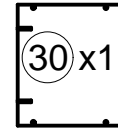

Box 2

70x498x16 mm

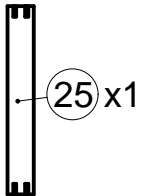

70x498x16 mm

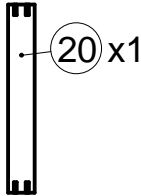

250x80x16 mm

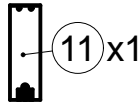

125x283x16 mm

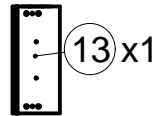

250x80x16 mm

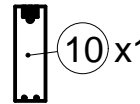

230x80x16 mm

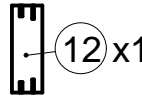

799x99x16 mm

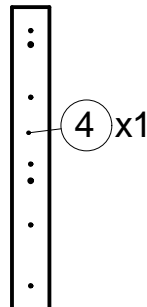

1546x125x16 mm

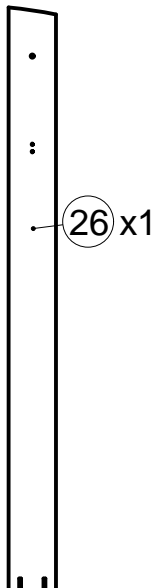

1516x125x16 mm

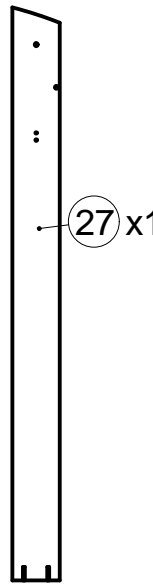

70x253x16 mm

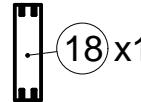

799x99x16 mm

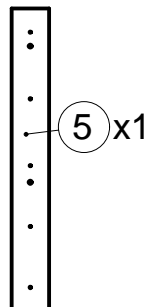

Box 3

1550x446x20 mm

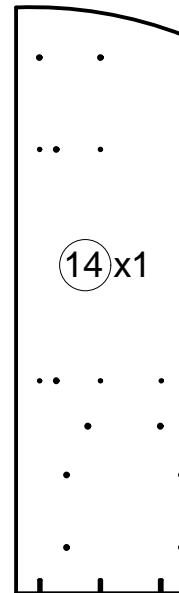

1

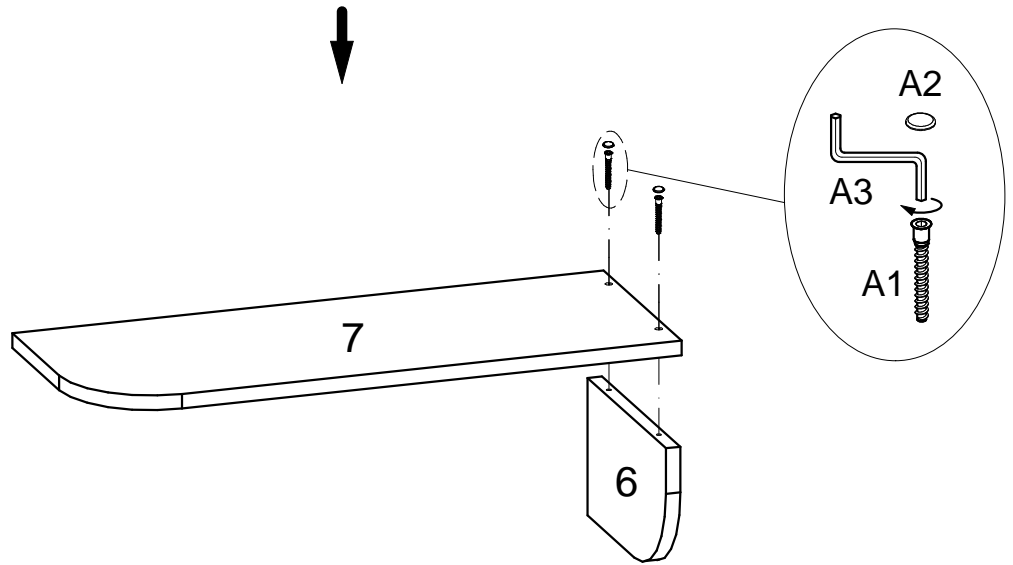
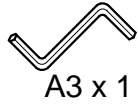
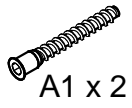

2

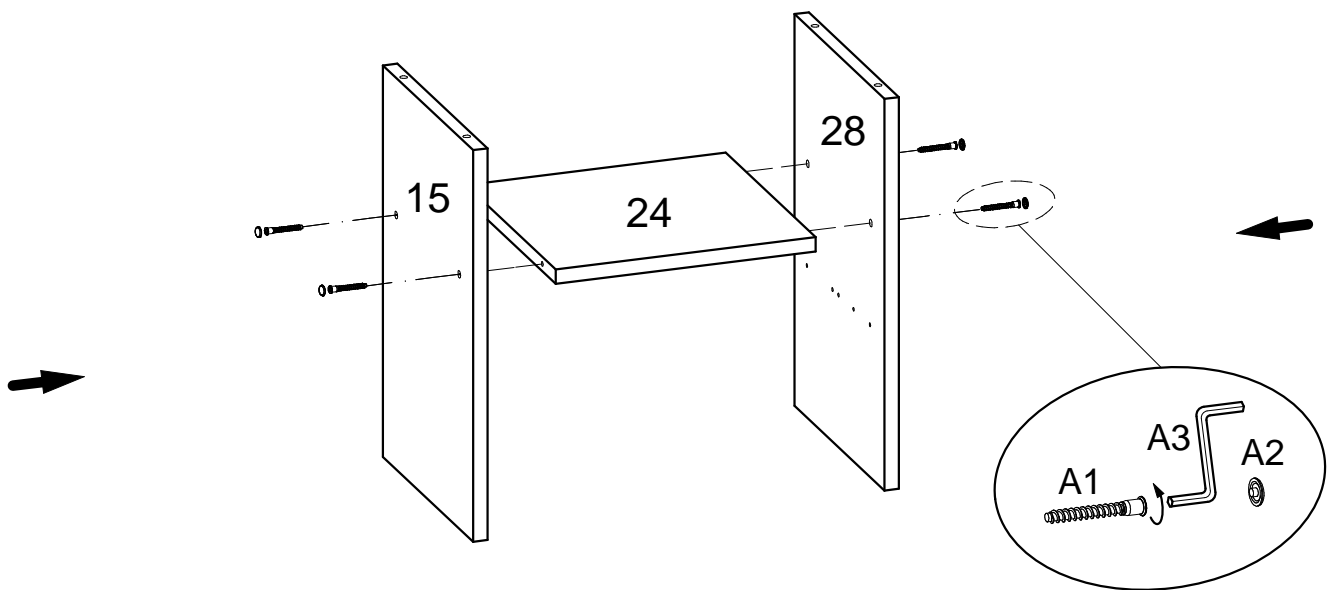
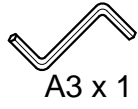
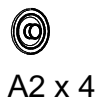
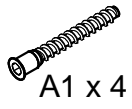

3

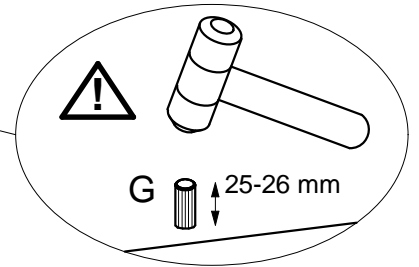
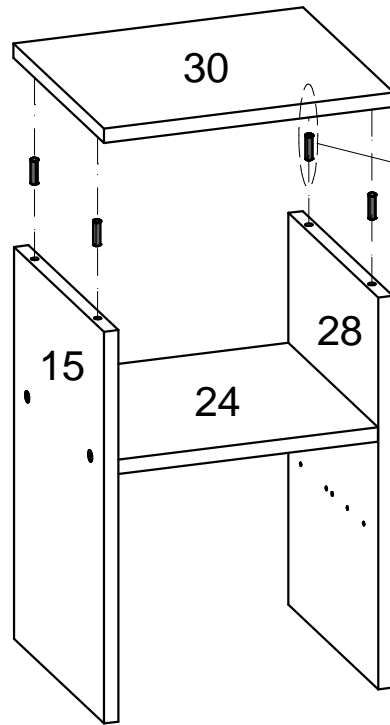
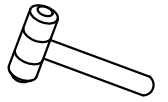

4

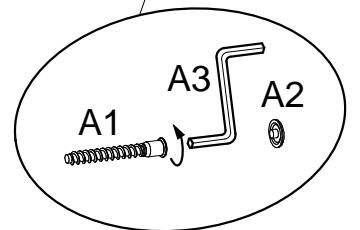
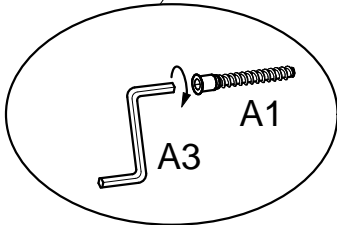
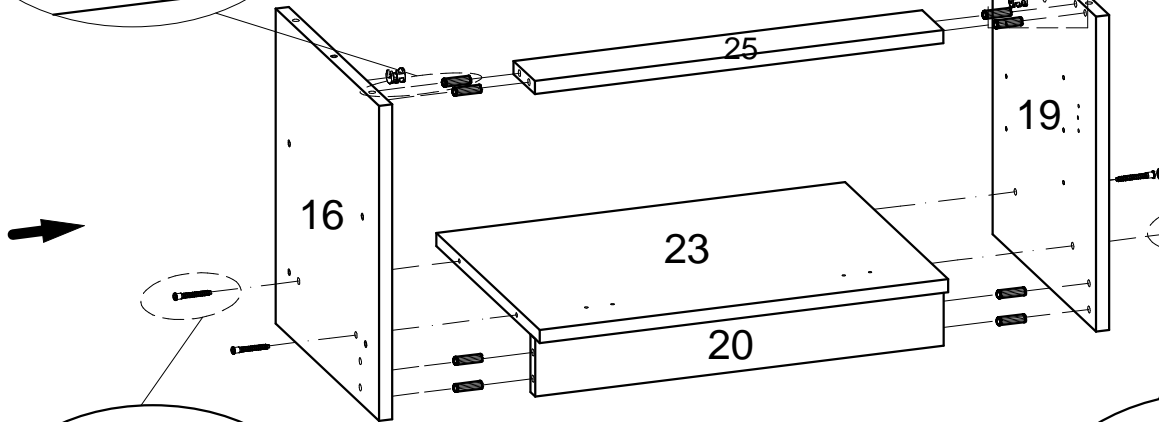
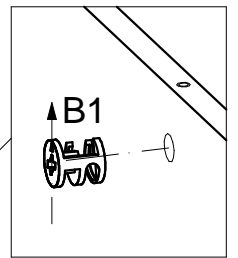
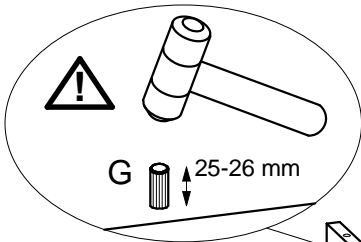
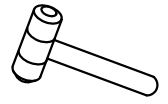
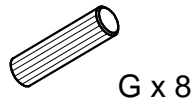
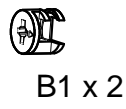
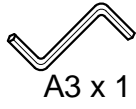
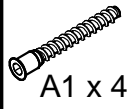

5



B1 x 3

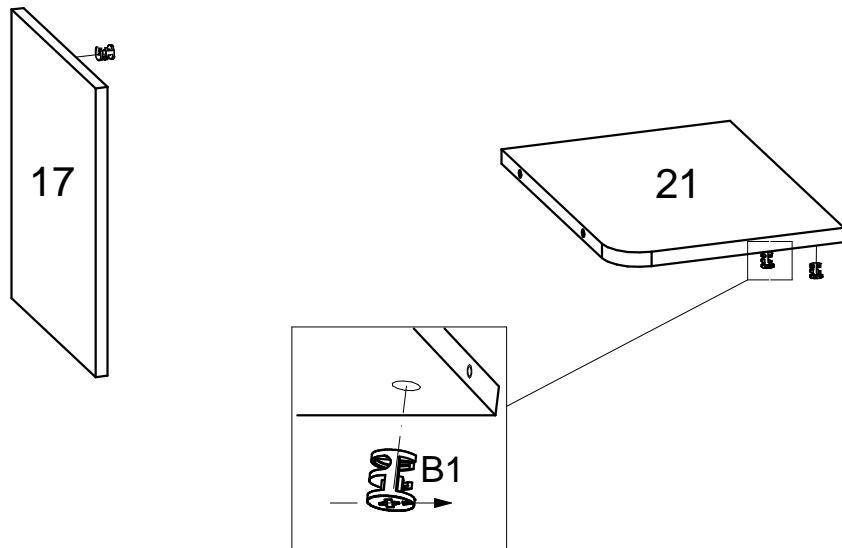

6

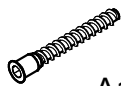

A1 x 6



A2 x 6



A3 x 1



B2 x 2



B3 x 2



G x 4

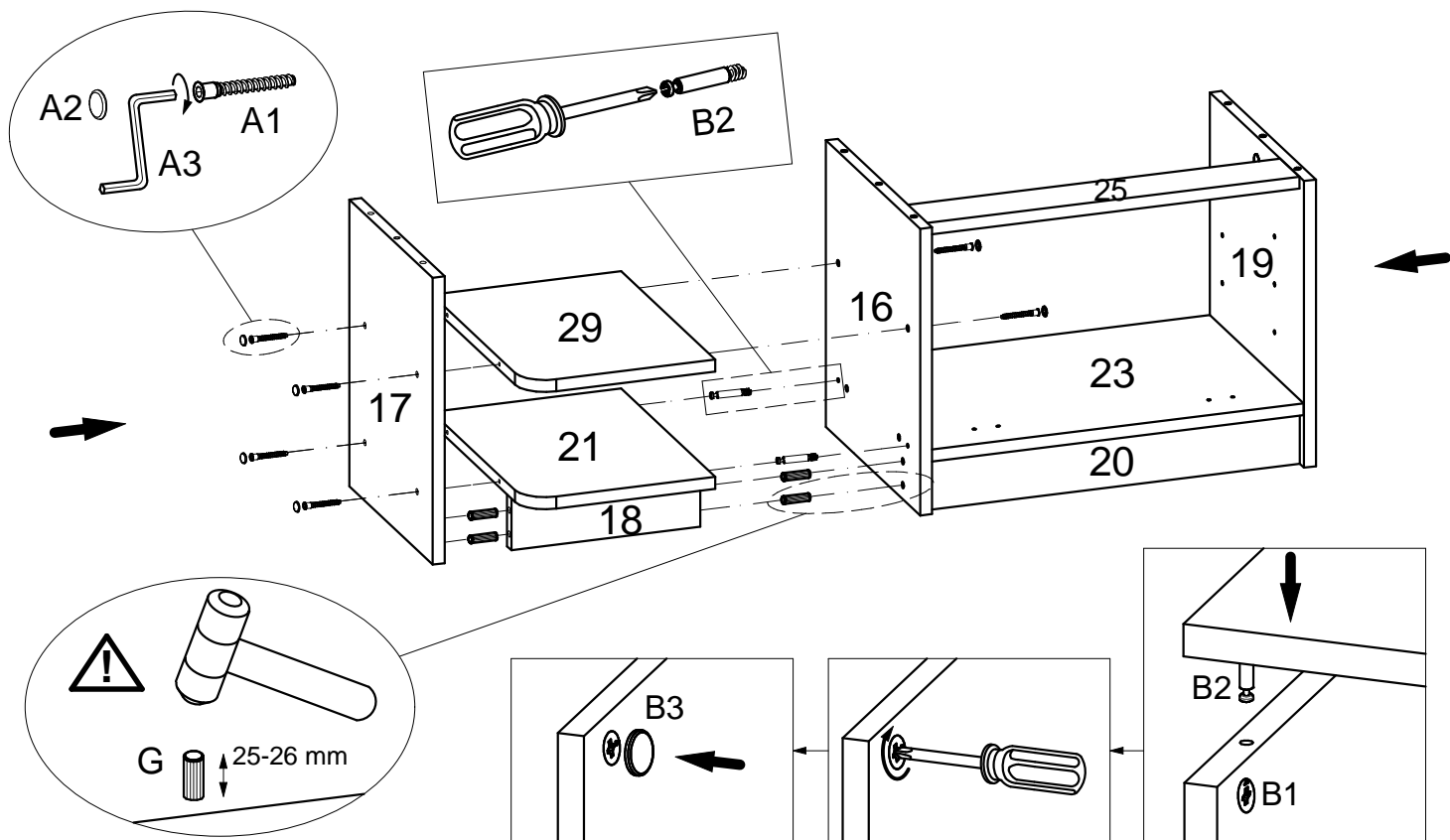
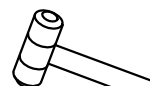
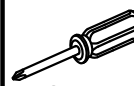

7





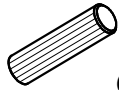

D3 x 10

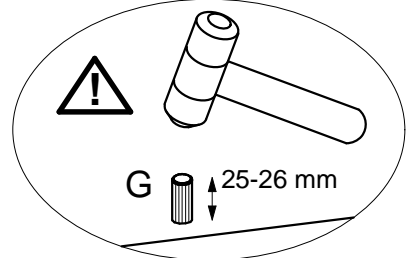
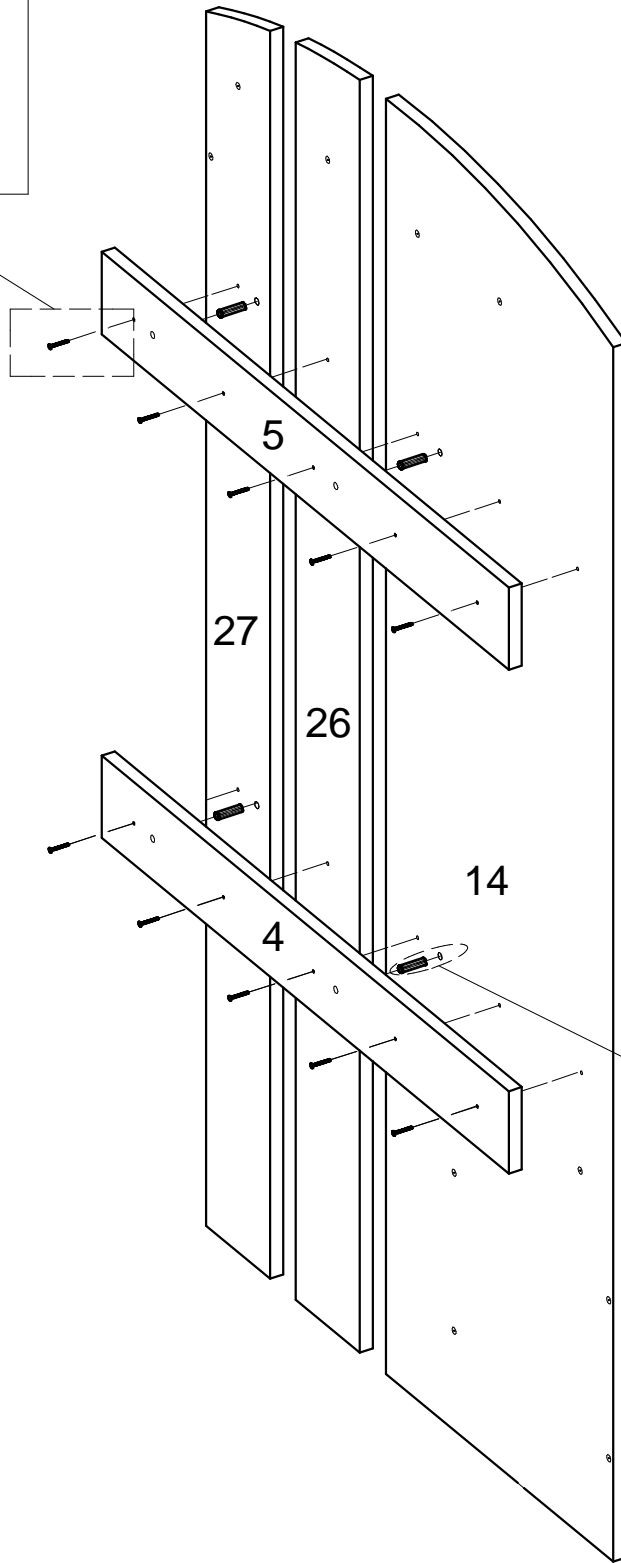
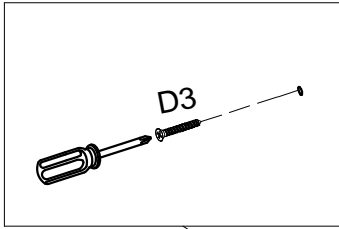
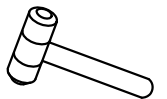
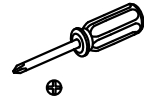

G x 4

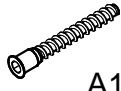

8

-  A1 x 11
-  A2 x 11
-  A3 x 1
-  V x 3

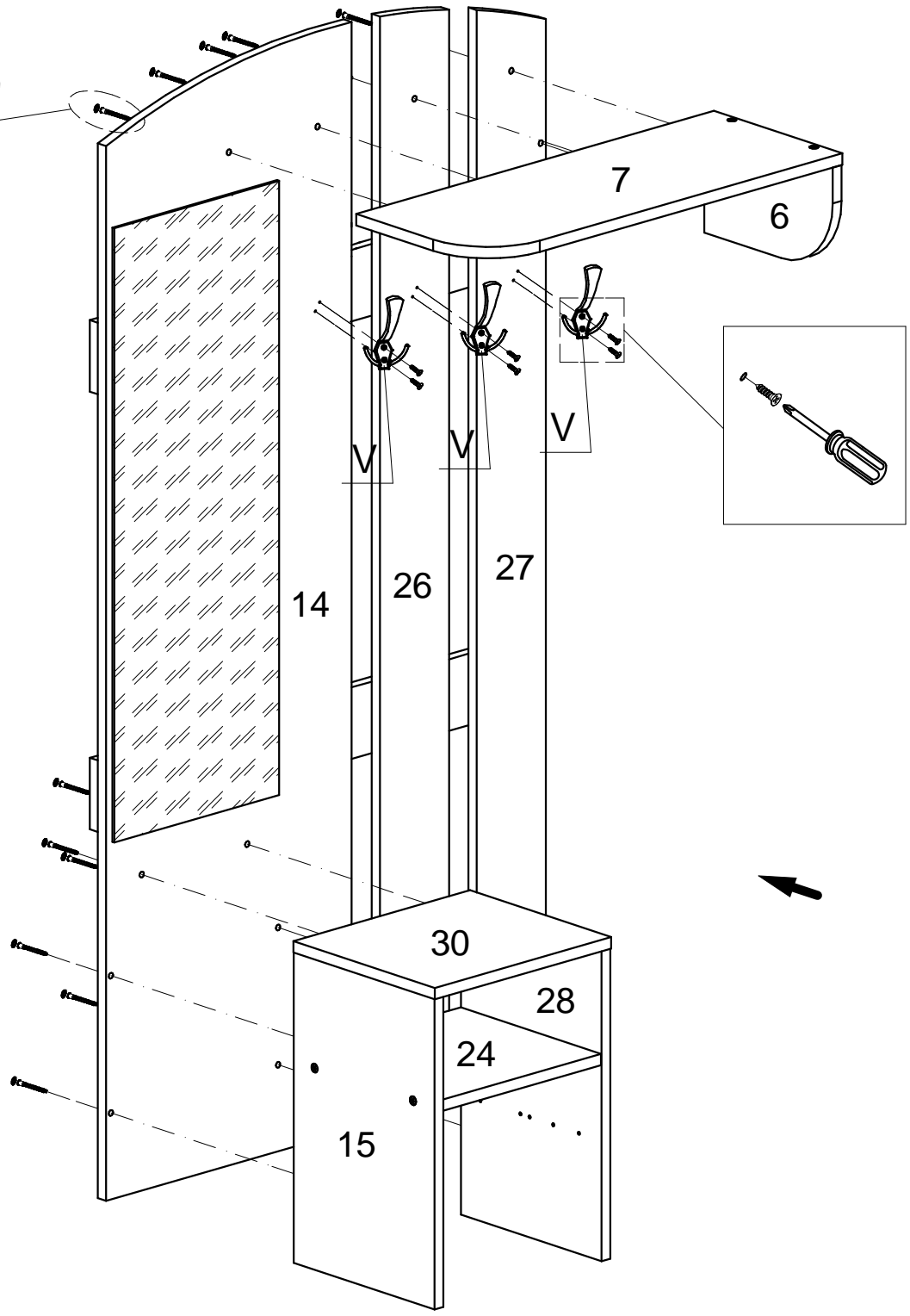
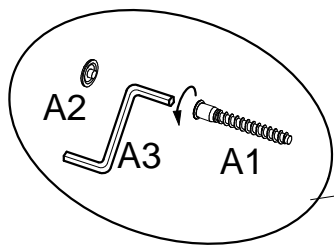
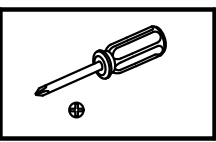

9

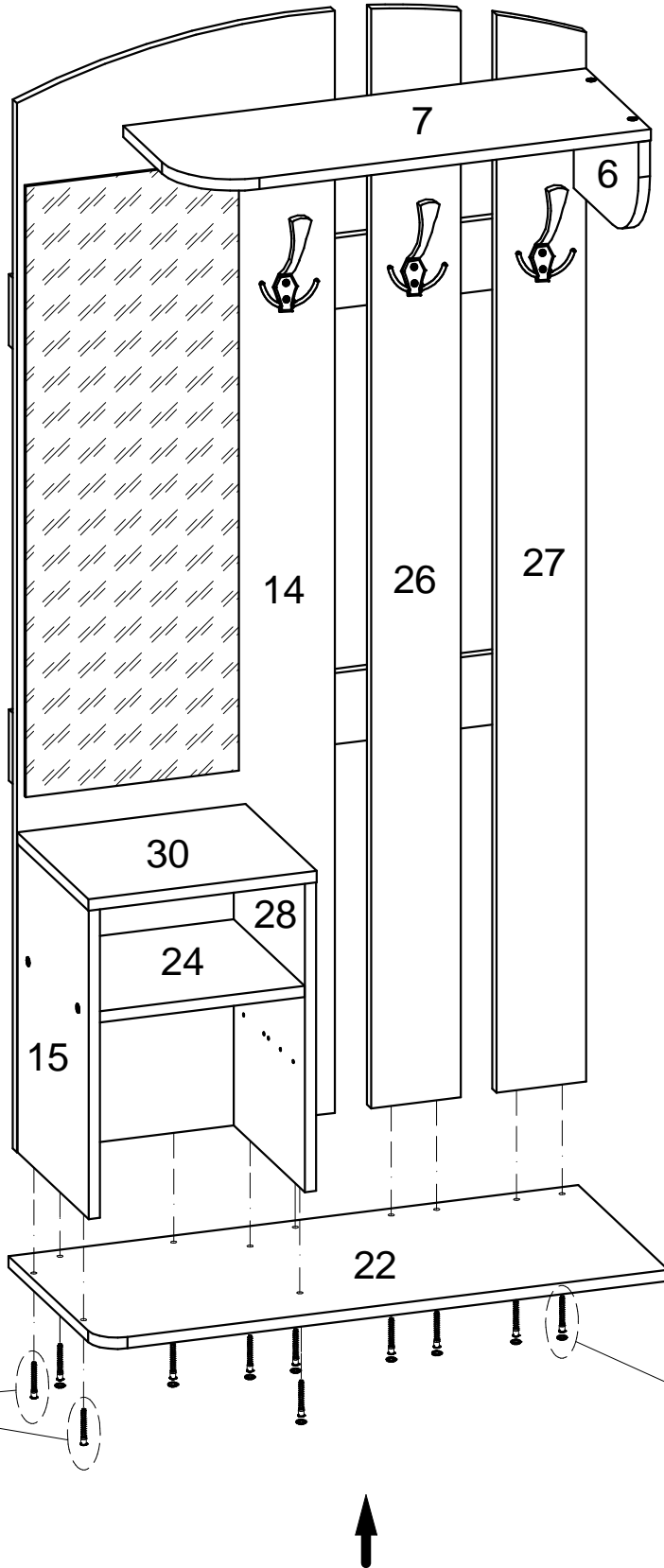
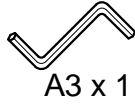

10

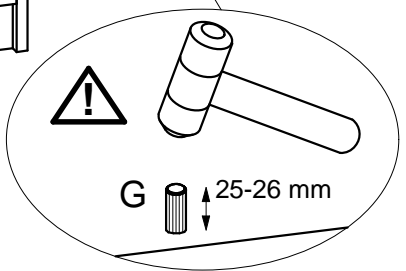
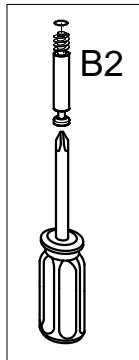
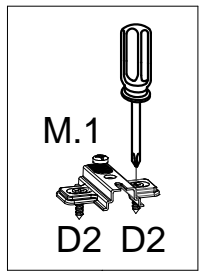
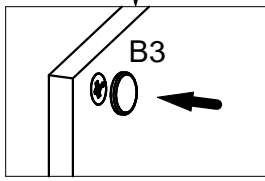
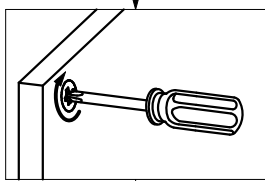
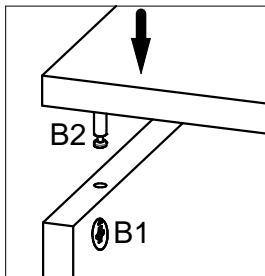
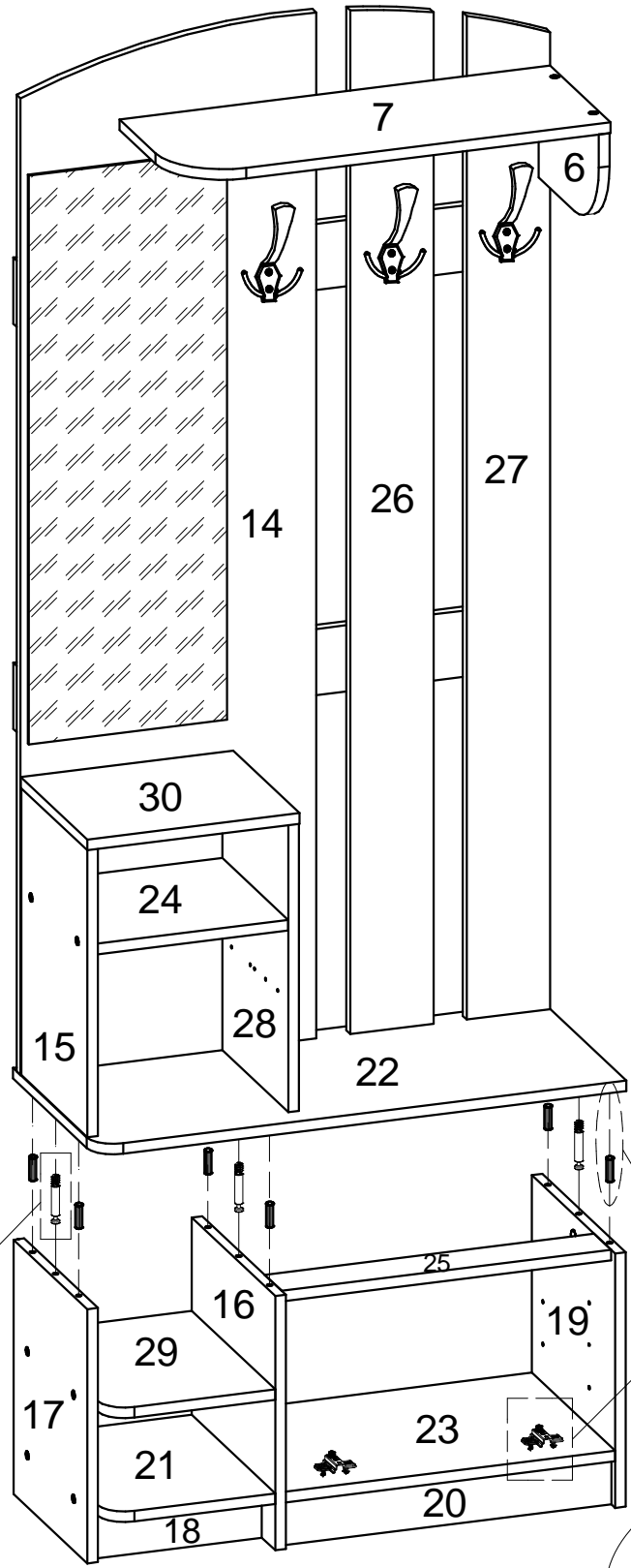
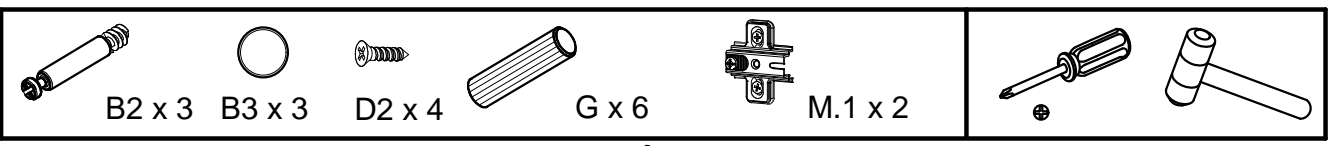

11

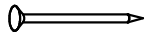

F x 43





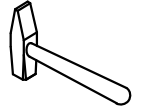



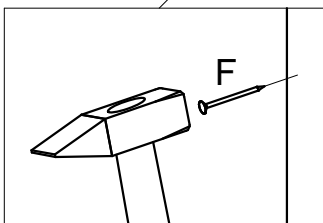
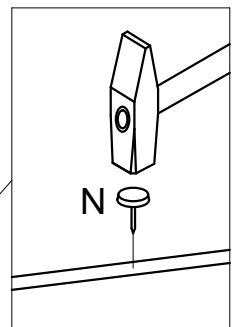
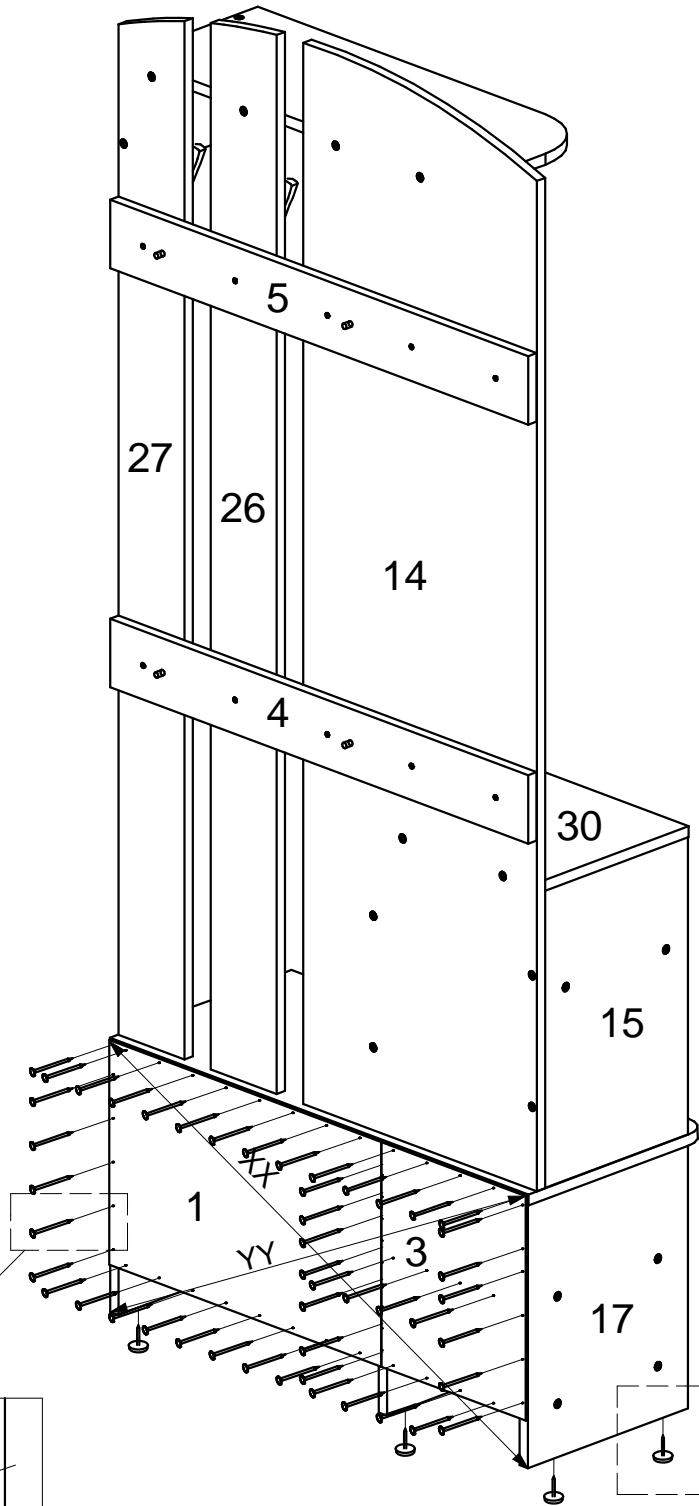

N x 6



 $XX=YY\equiv 90^\circ$

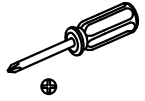

12

- | | | | | | |
|---|--|--|---|---|--|
|  D1 x 18 |  D2 x 4 |  D4 x 2 |  H x 1 |  K1 x 1 |  K2 x 1 |
|  L x 4 |  M.2 x 2 |  X x 2 |  | | |

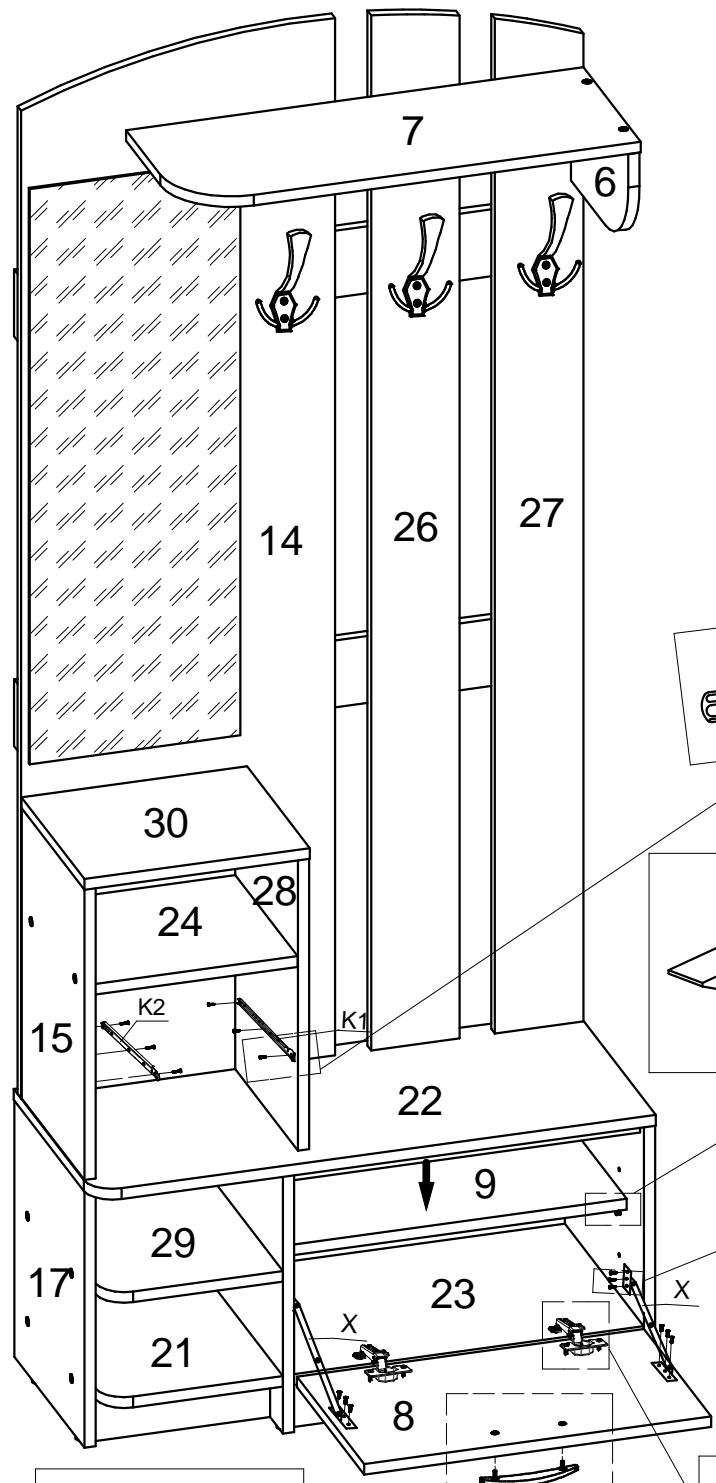

13

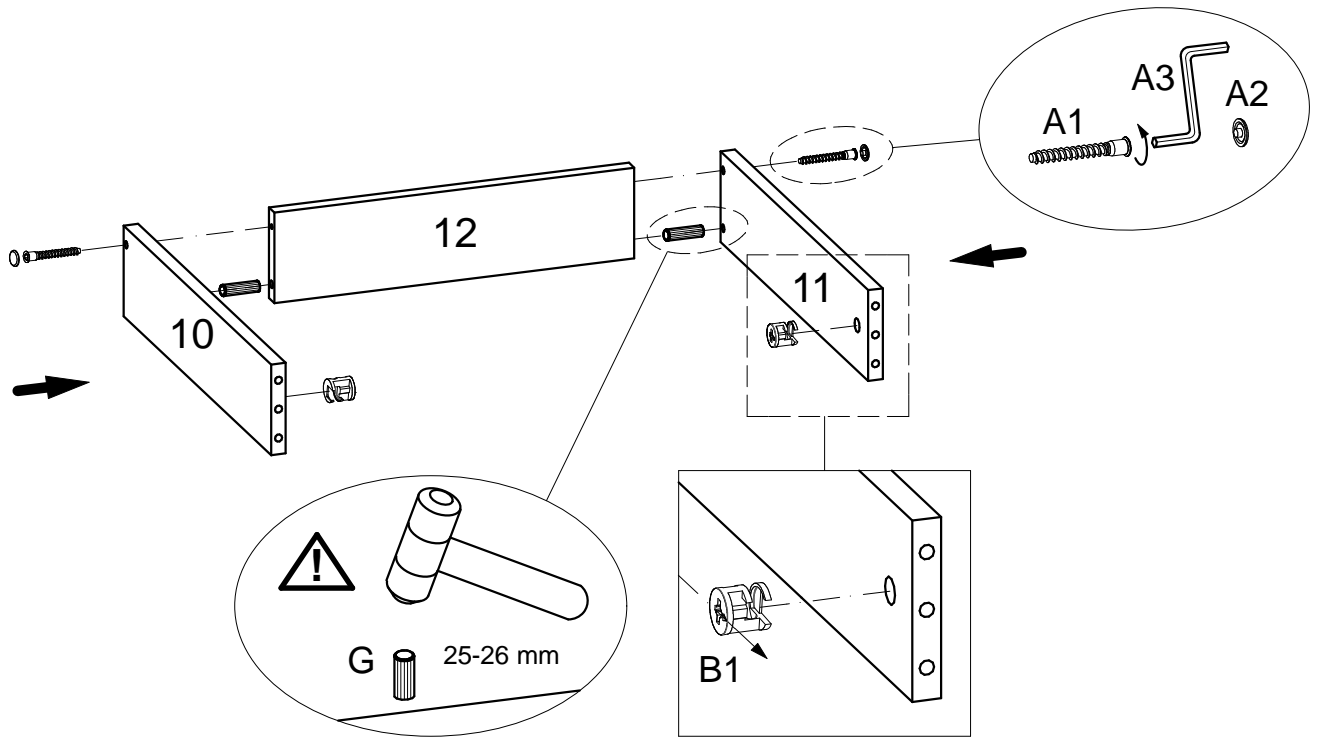
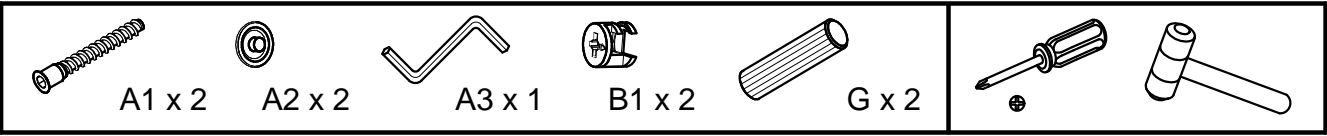

14

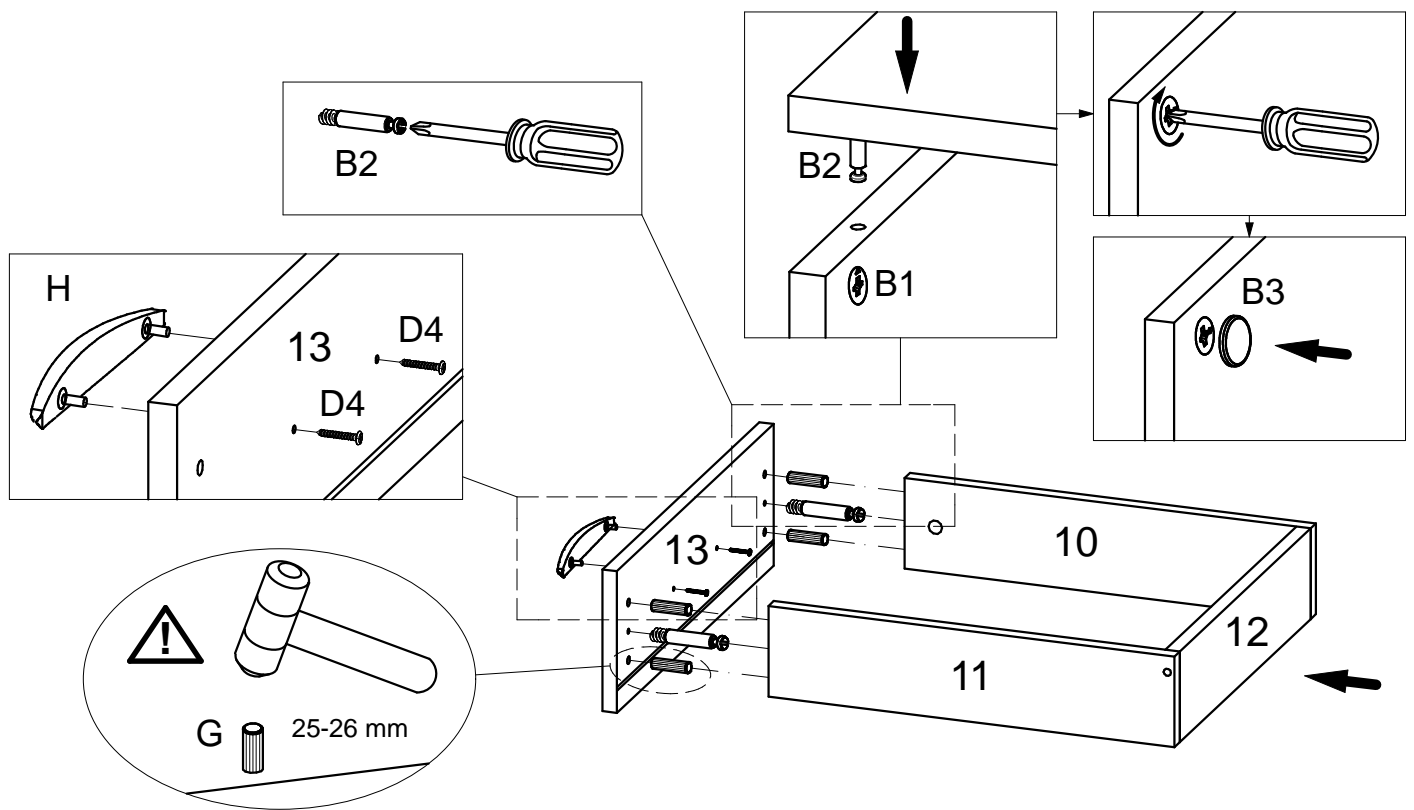
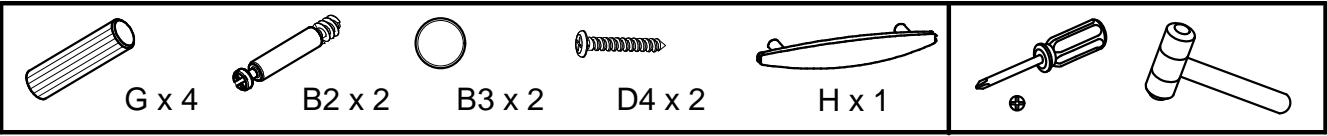

15

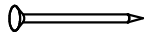

F x 17

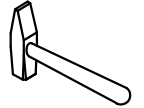

 $XX=YY\cong 90^\circ$

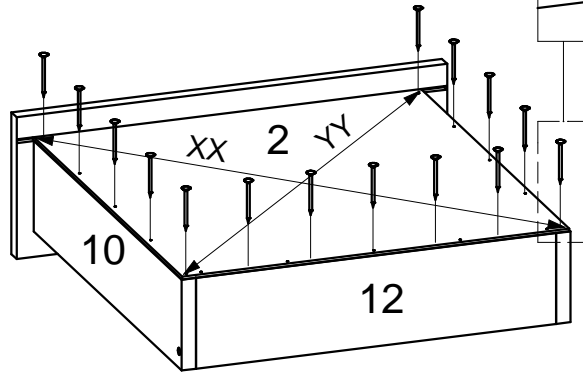
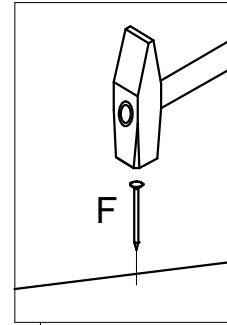

16



D2 x 6

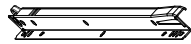

K3 x 1

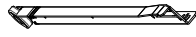

K4 x 1

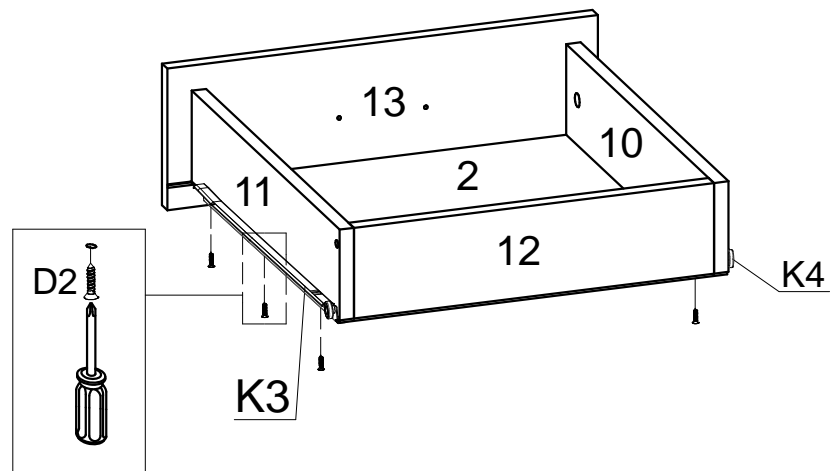
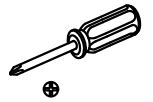

17

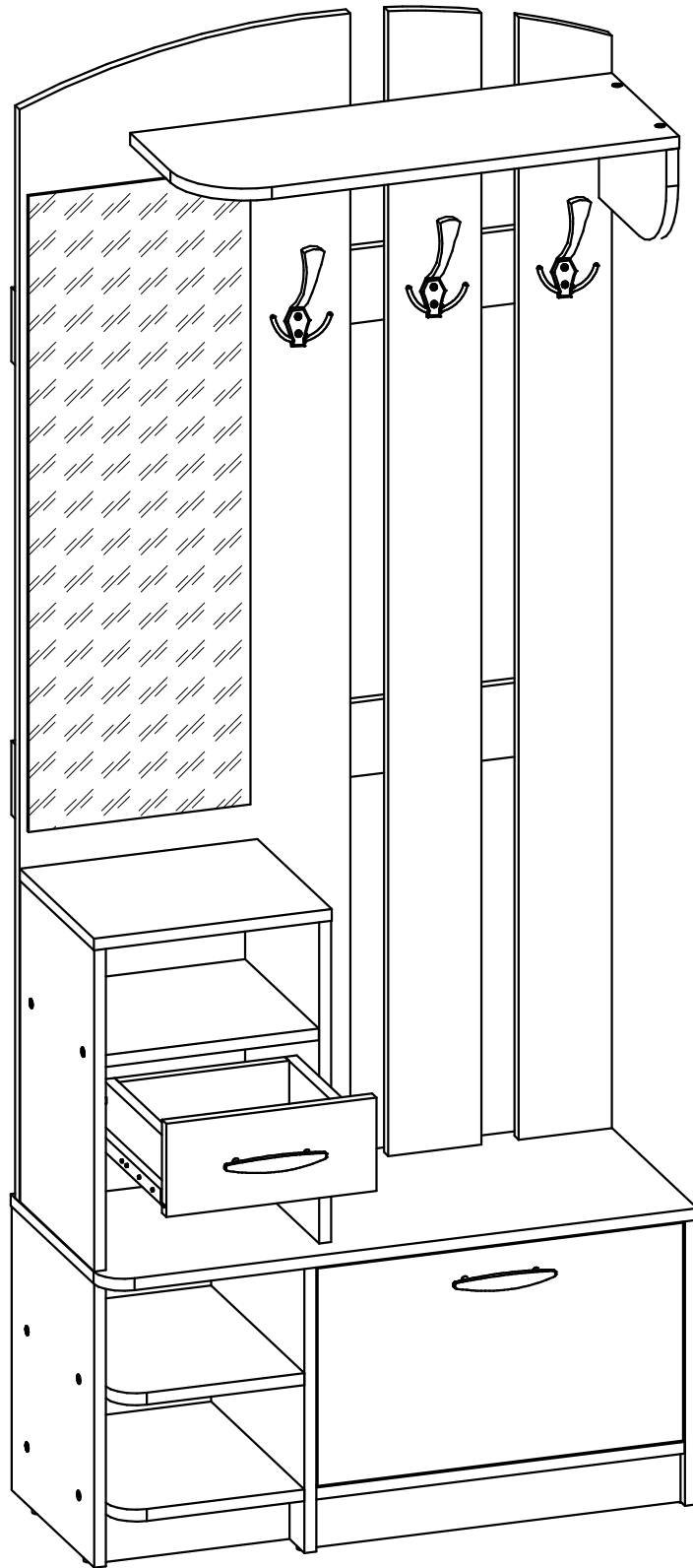

18

