











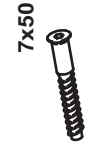
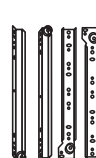

32 X 3,5x13 	5 X S01 	4 X W04 
4 X L+P P01 	50 X G01 	1 X K01 
2 X L01 	66 X D01 8x28 	4 X Z01 
25 X T02 	21 X T01 	8 X E01 
4 X Z02 	2 X T03 	8 X W01 3,5x15 

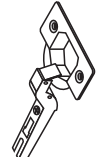
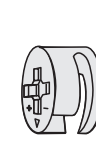
0 10 20 30 40 50 60 70 80 90 100 110 120 130 140 150 160 170 180 190 200



1

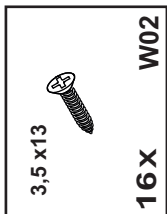
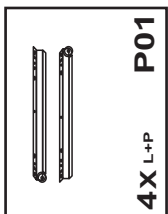
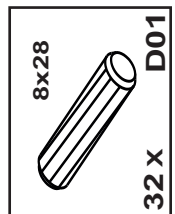
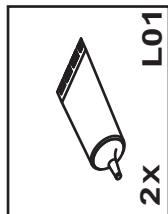
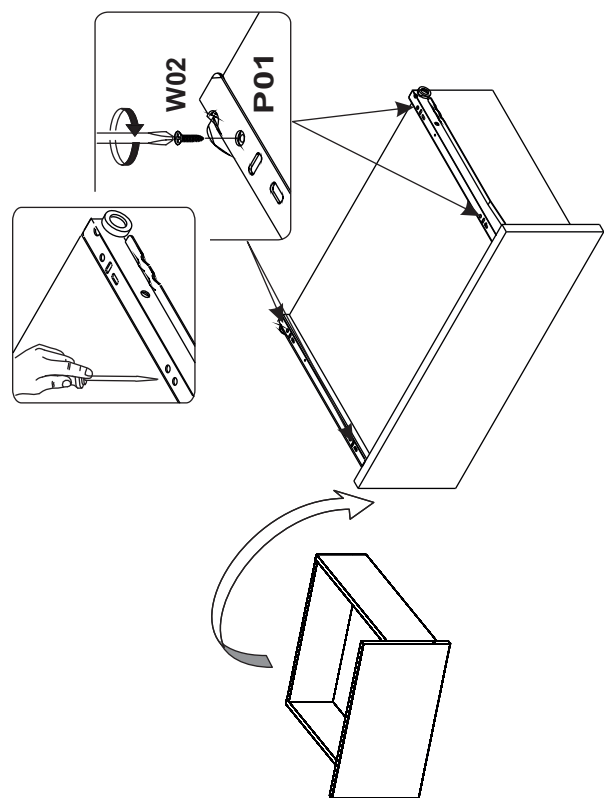
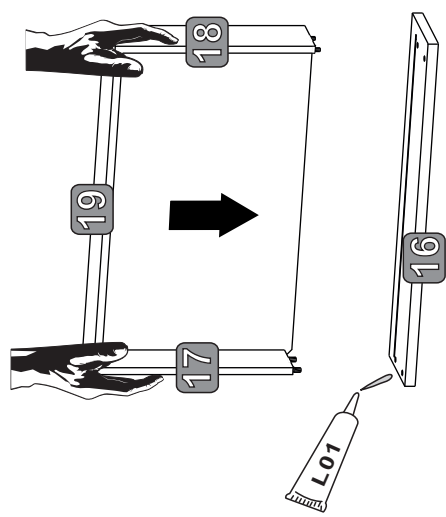
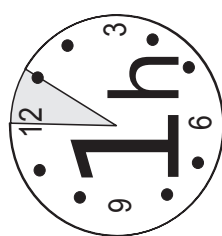
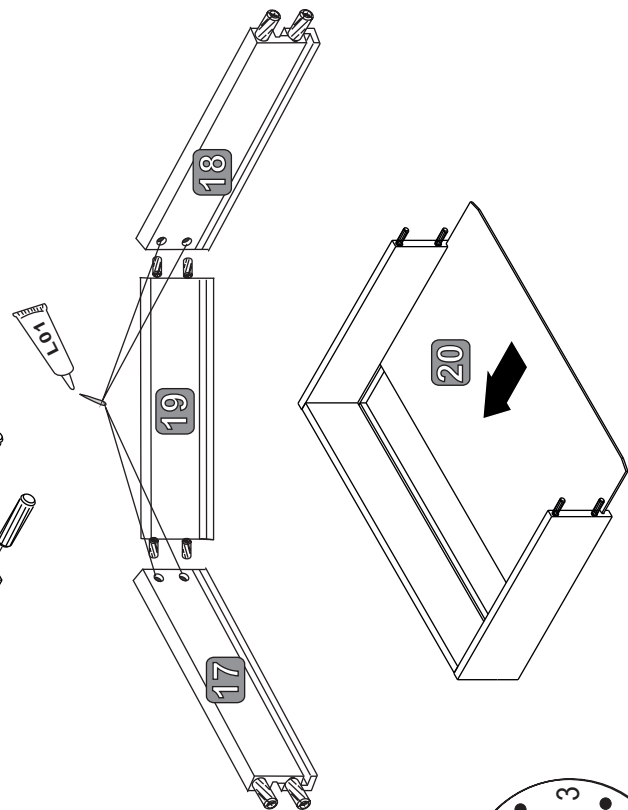
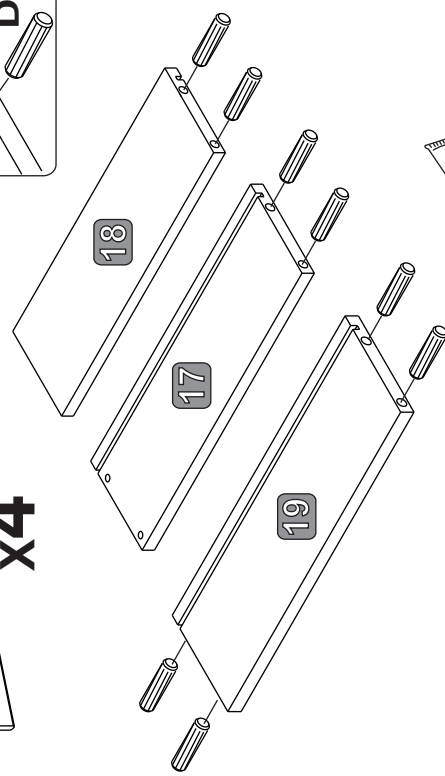
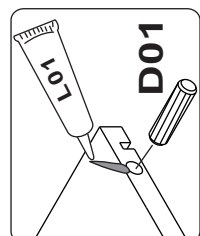
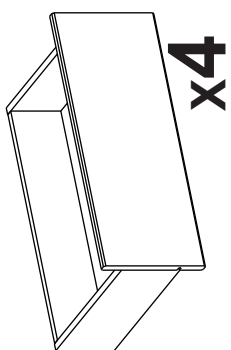

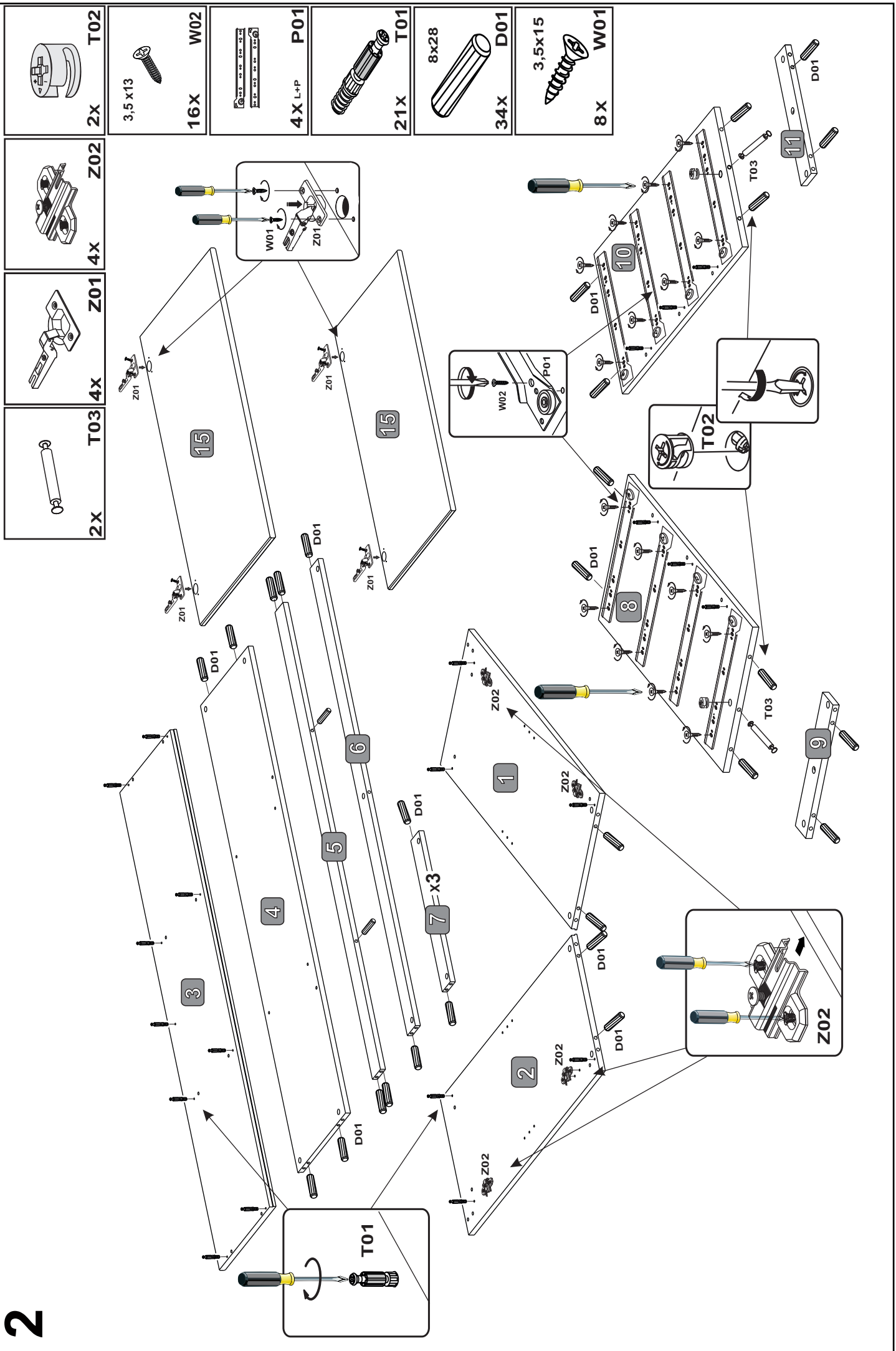

**T02**  
2X

**Z02**  
4X

**Z01**  
4X

**T03**  
2X

**W02**  
16X

3,5x13

**P01**  
4X L+P

**T01**  
21X

**D01**  
34X

8x28

**W01**  
8X

3,5x15

**T01**

**Z02**

**W02**  
**P01**

**W01**  
**Z01**

**T02**

**D01**

**9**

**10**

**11**

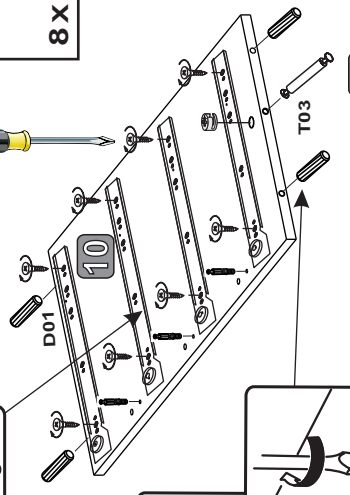
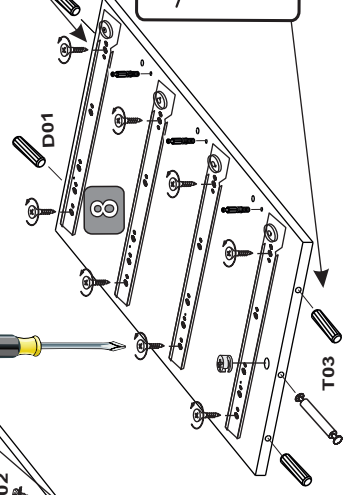
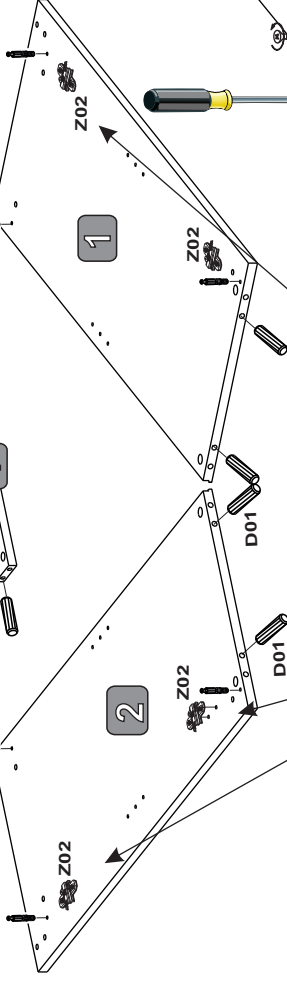
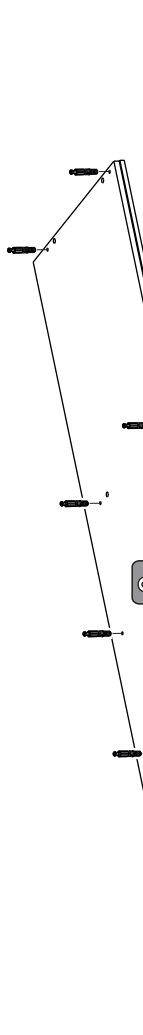
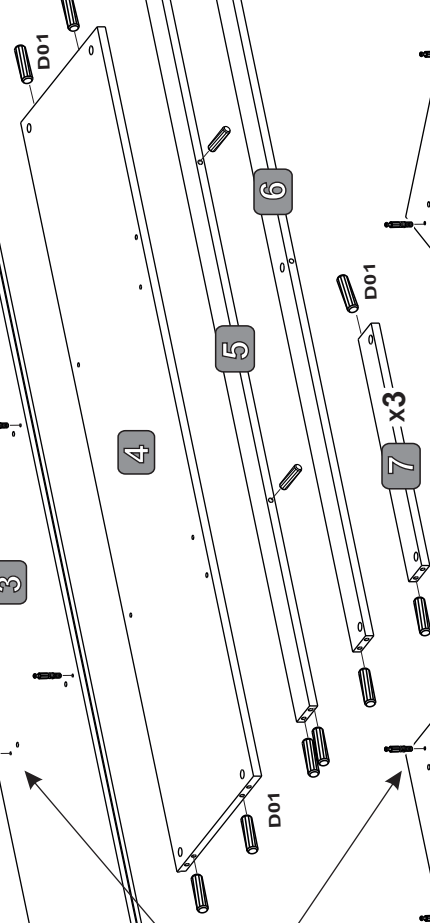
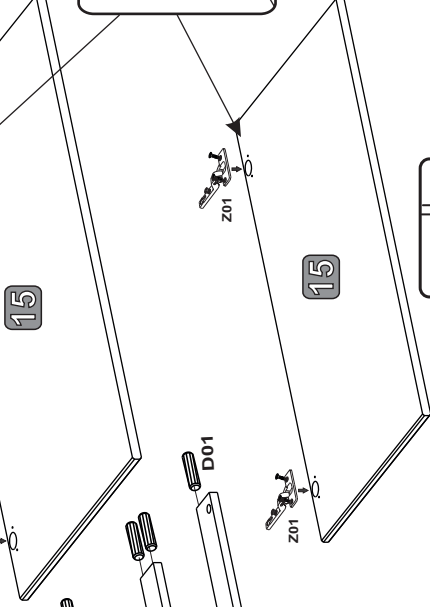

3

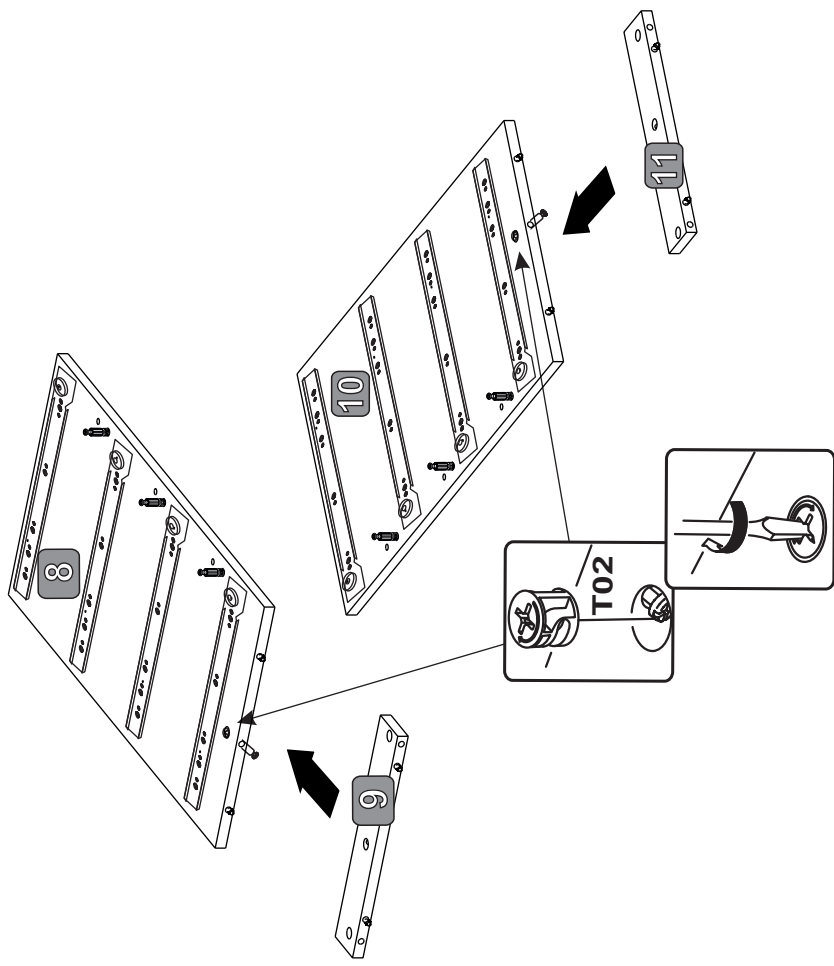
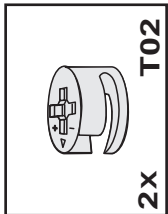

4

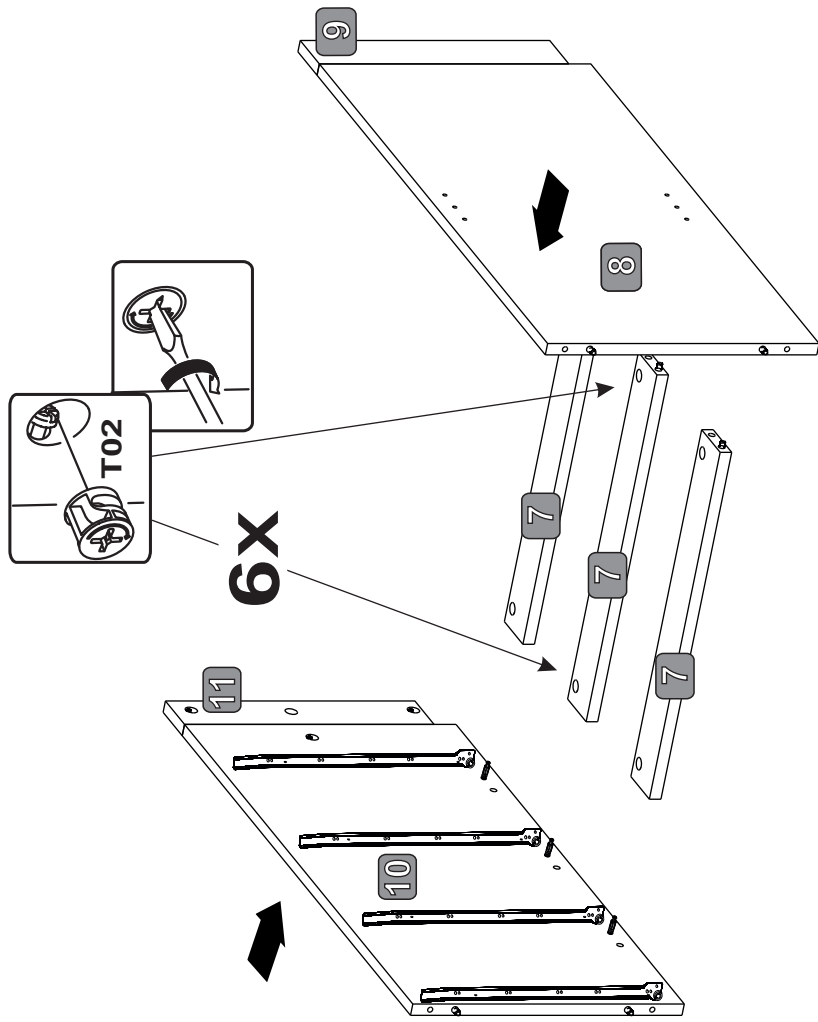
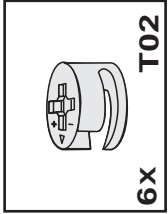

5

5

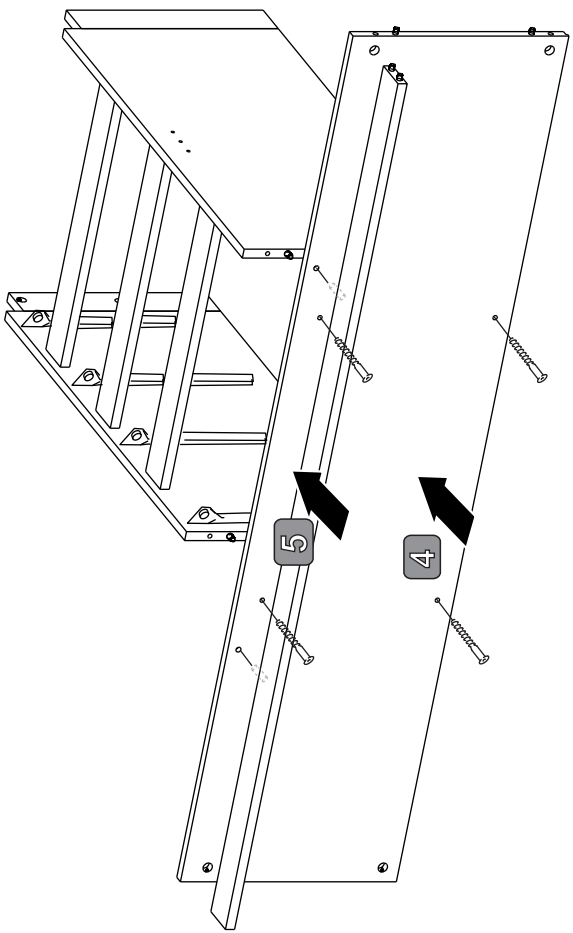
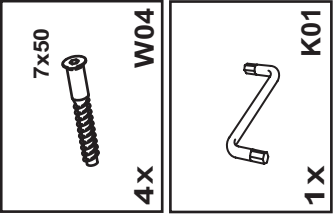

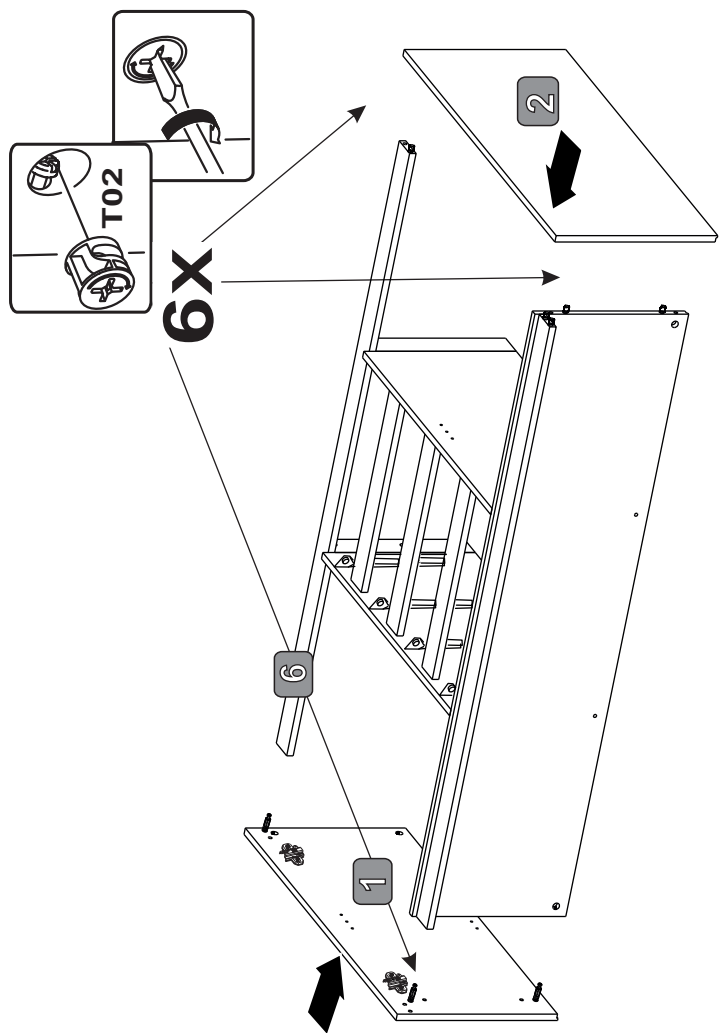
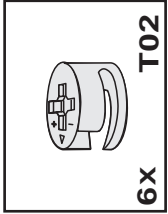

6



6

7

	<b>50x</b>	<b>G01</b>
	<b>5x</b>	<b>S01</b>

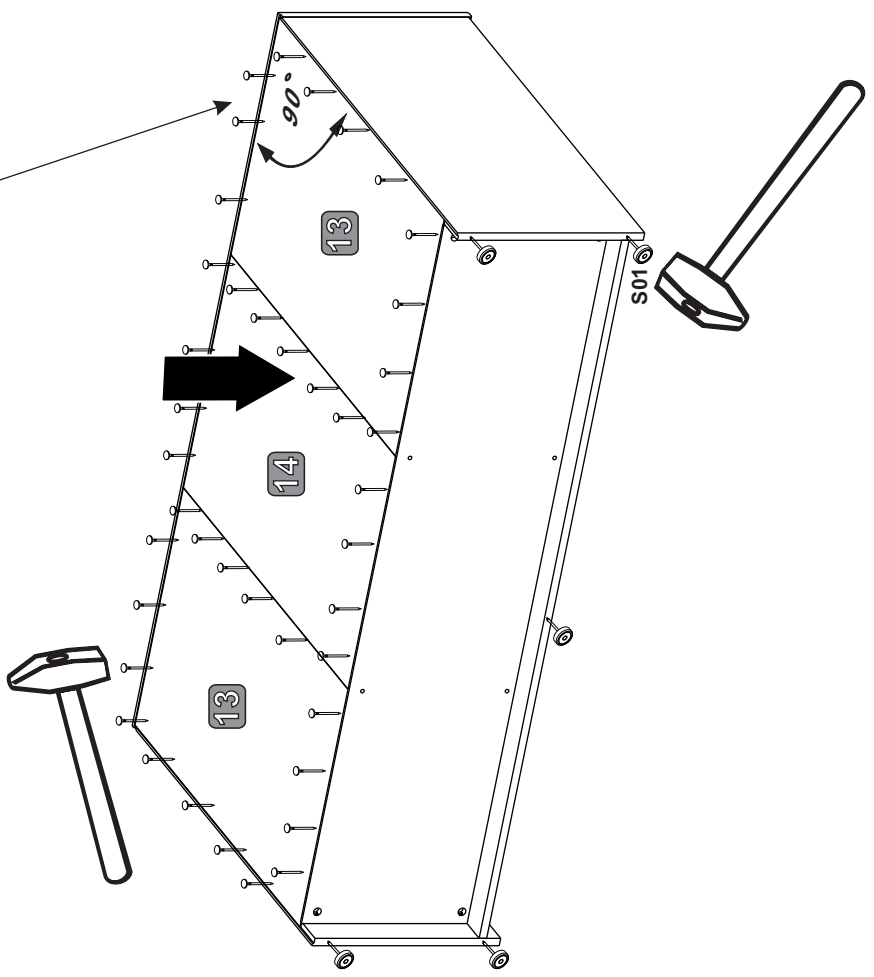
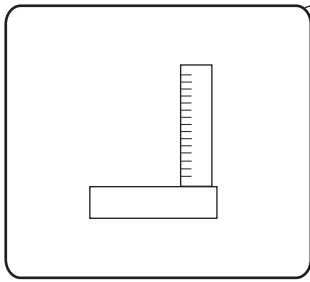

8

	<b>9x</b>	<b>T02</b>
---	-----------	------------

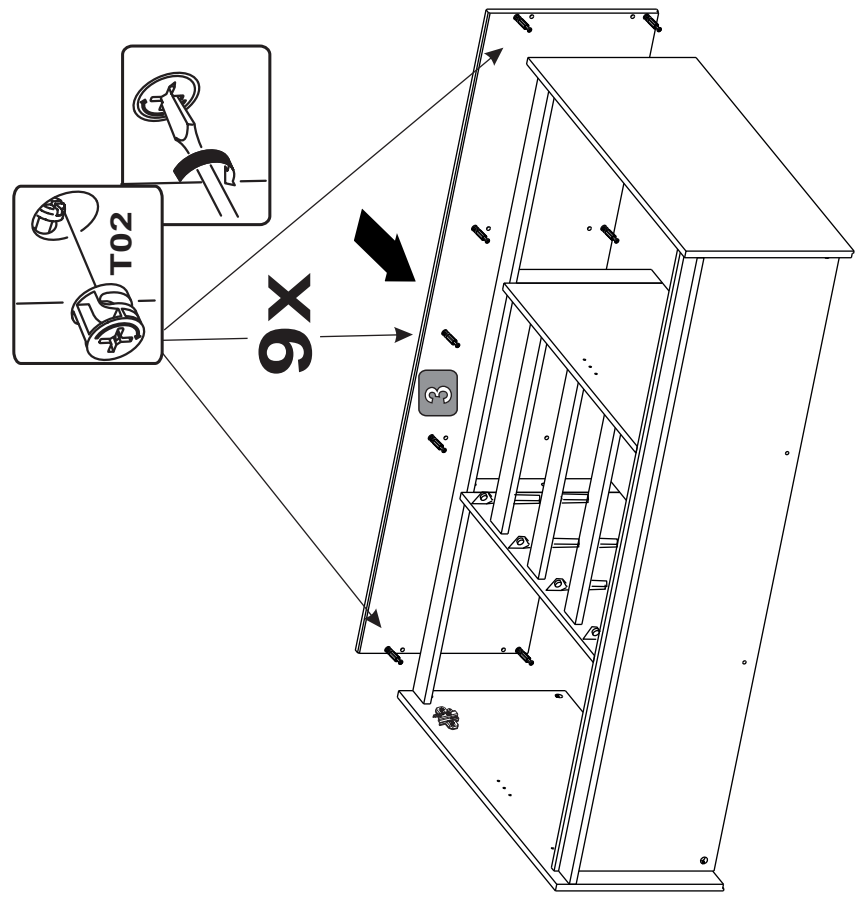

7

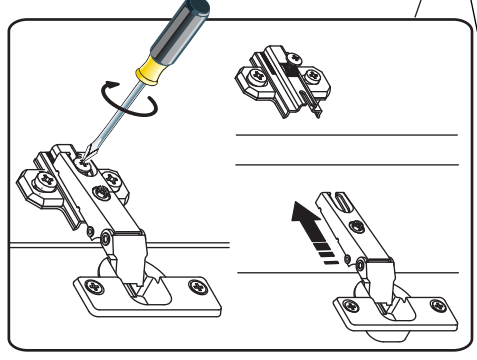

10

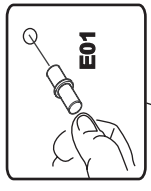
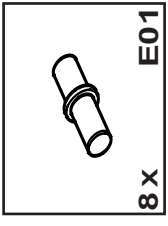
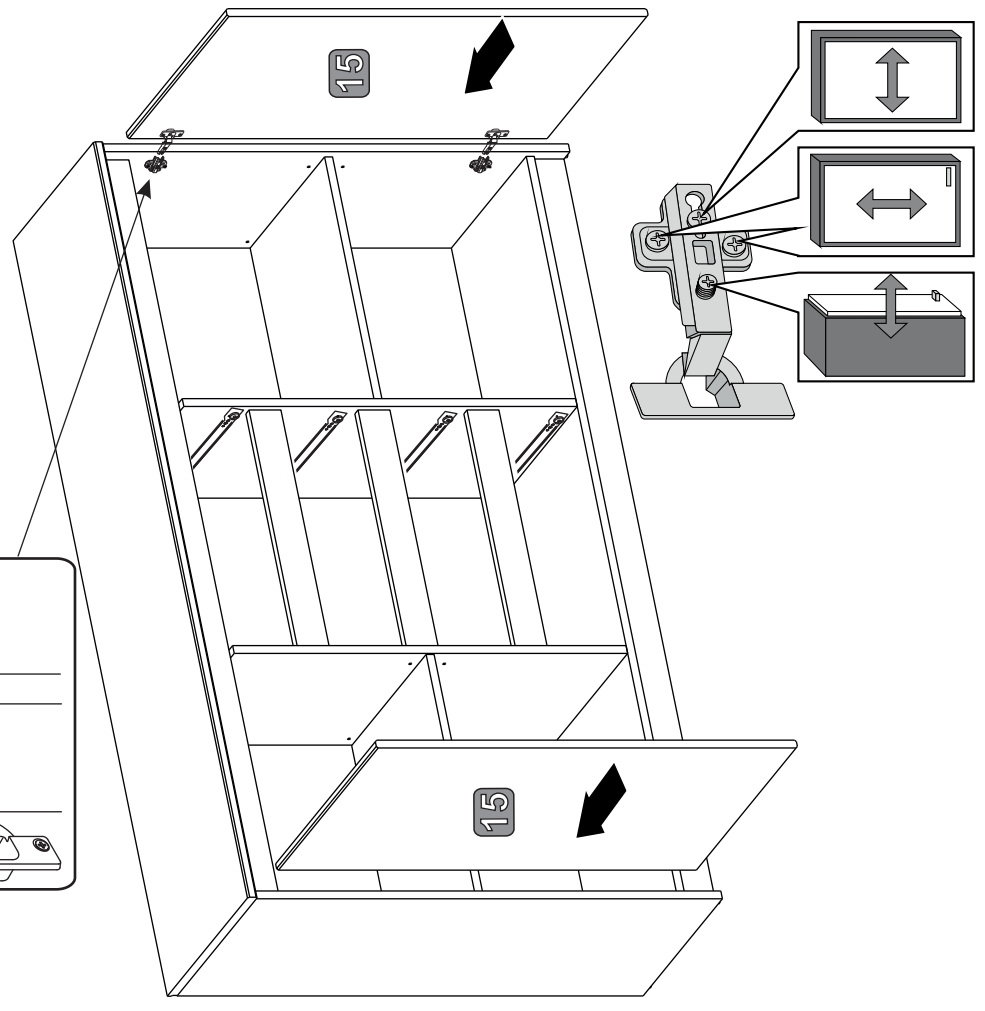

9

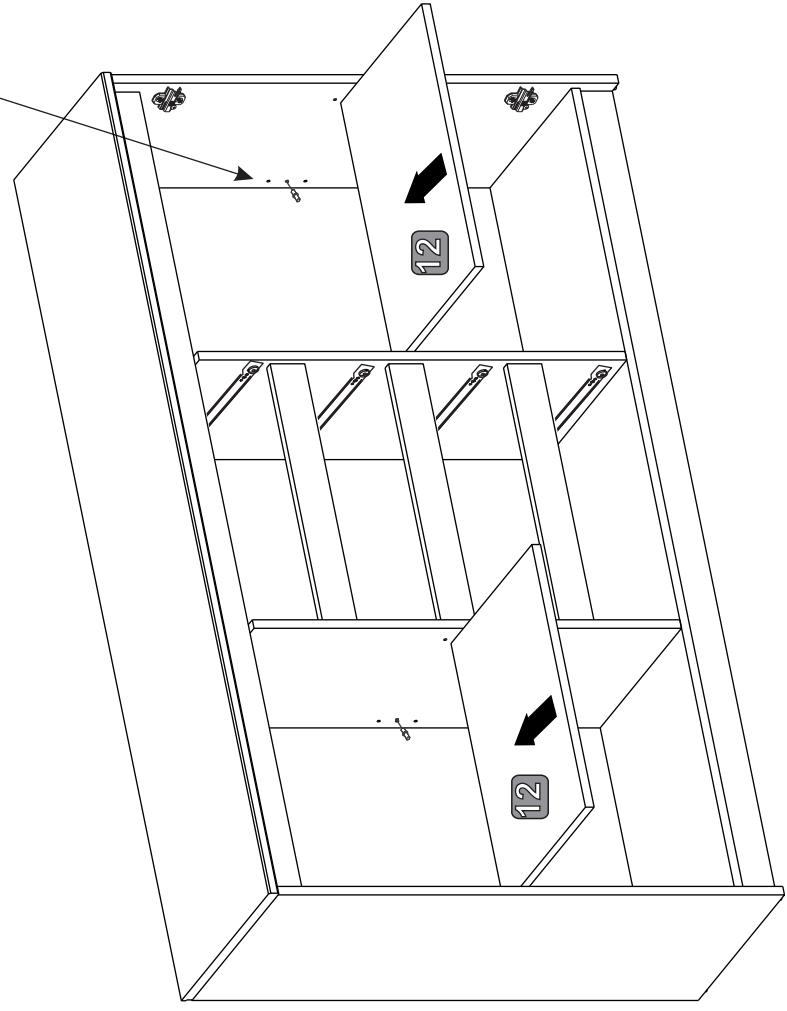



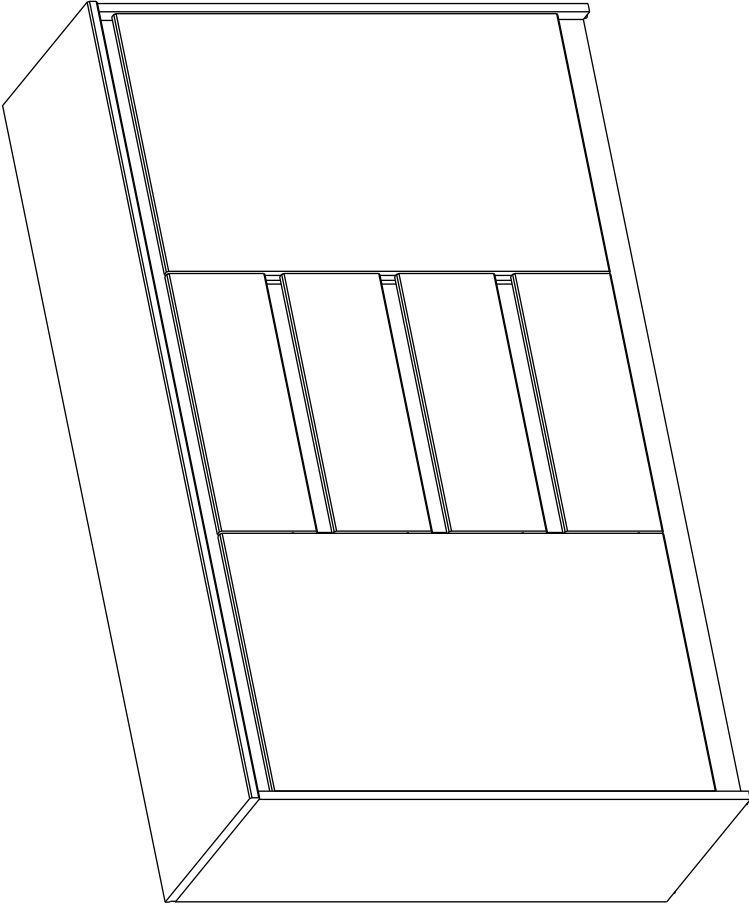

9

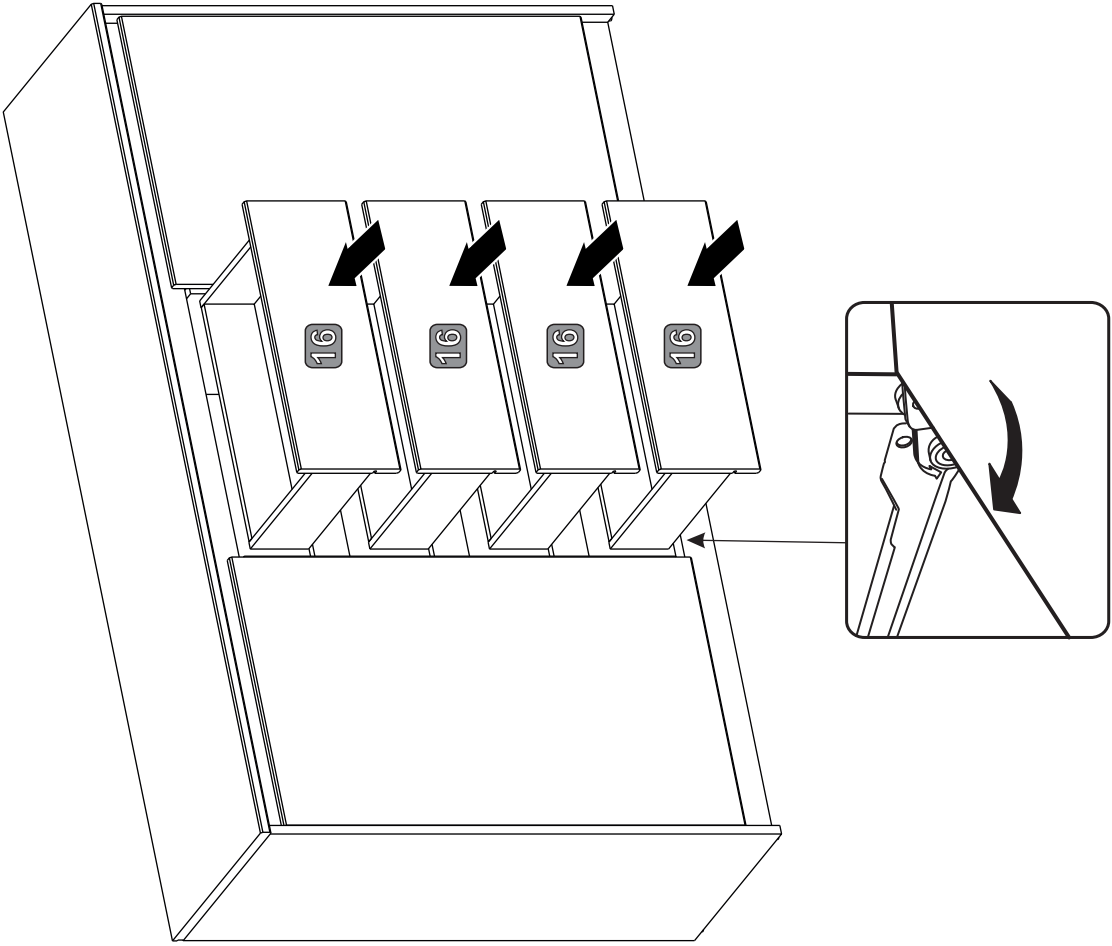

9