

No	a*b	X
1	1260x320	1
2	308x314	2
3	308x340	2
4	1280x340	1
5	1280x340	1
6	1276x337	1

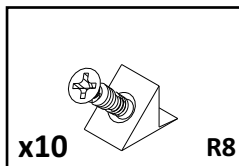

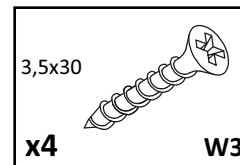
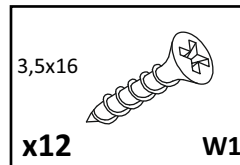
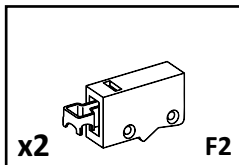
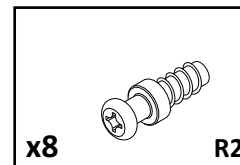
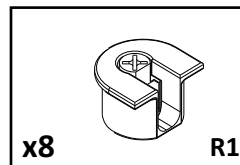
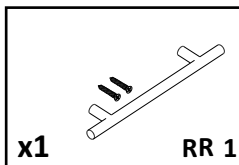
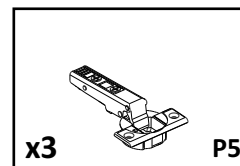
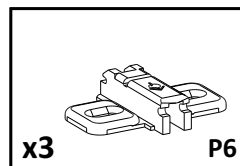
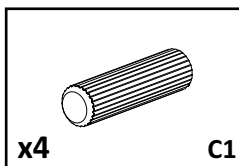
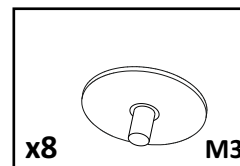
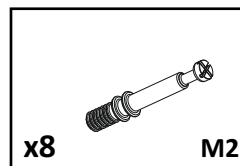
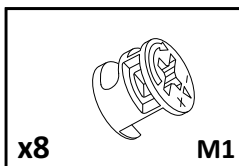
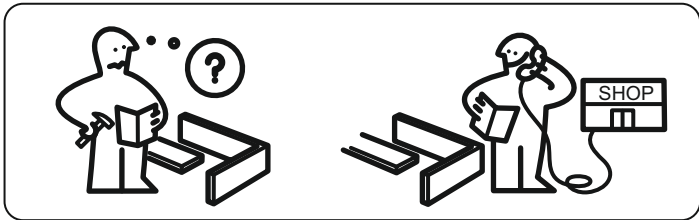
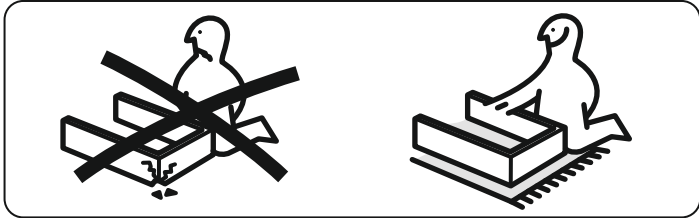
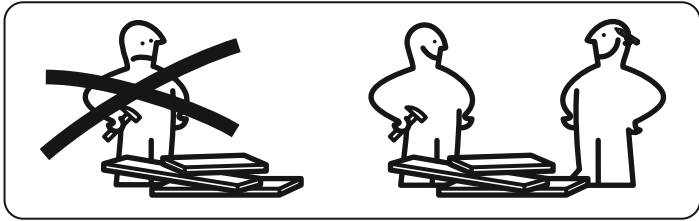
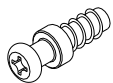
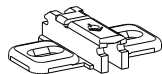

**1****x8****R2****x3****P6**

3,5x16

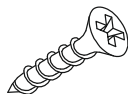
**W1**

3,5x30

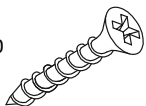
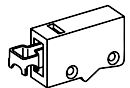
**x4****W3****x2****F2**

16 mm

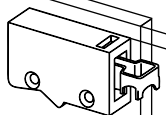

16 mm

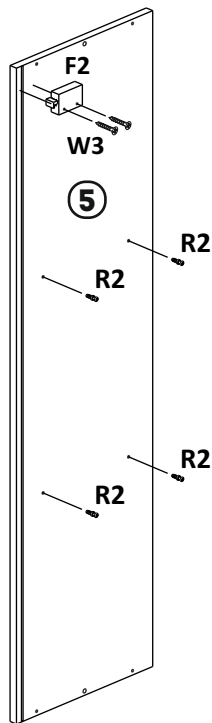
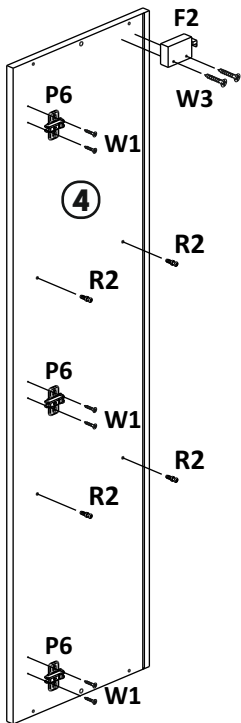
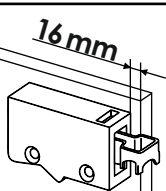
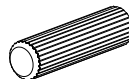
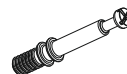
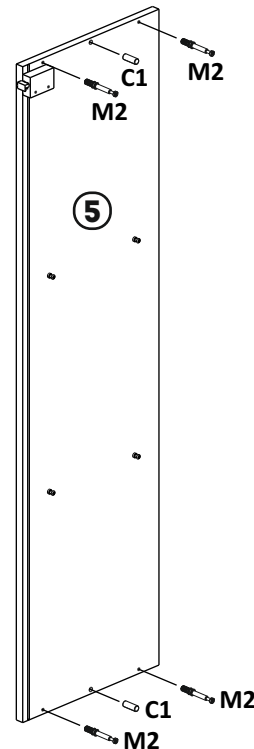
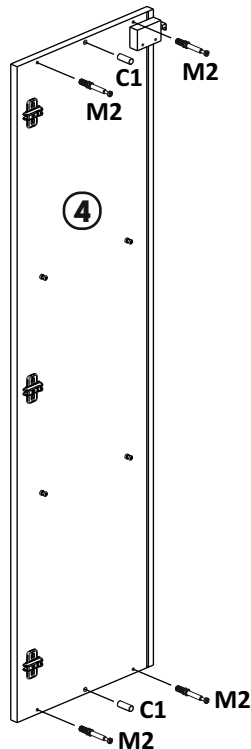
**2****x4****C1****x8****M2**

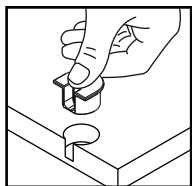
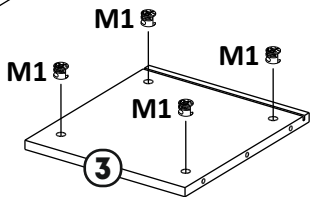
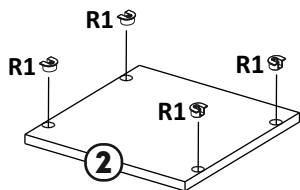
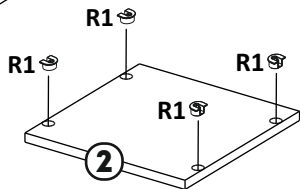
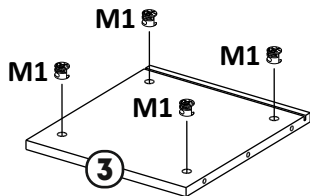
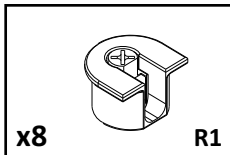
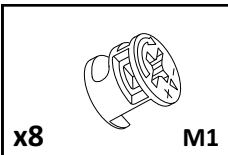
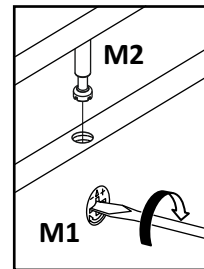
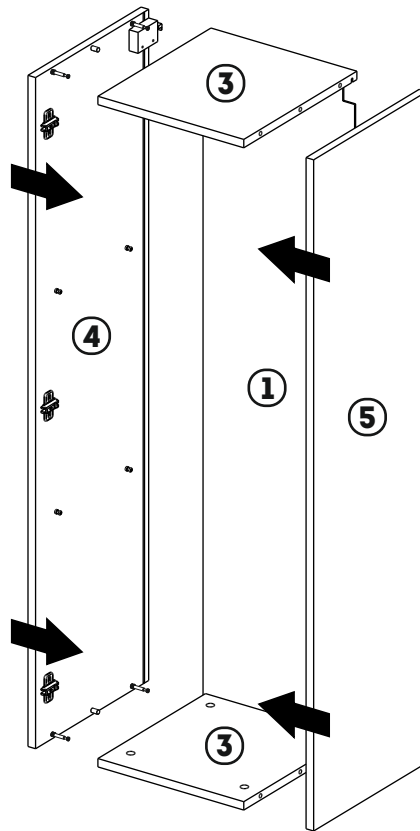
**3****4**

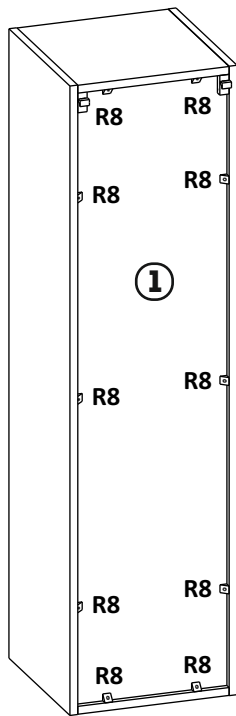
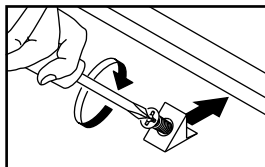
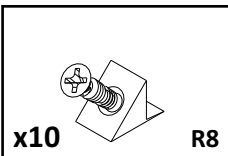
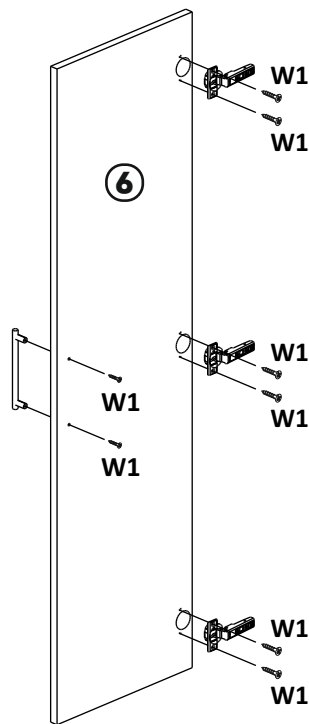
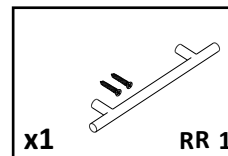
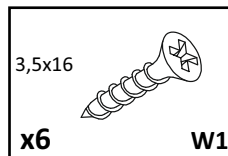
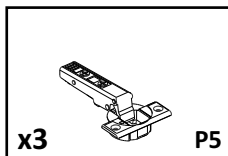
**5****6**

7

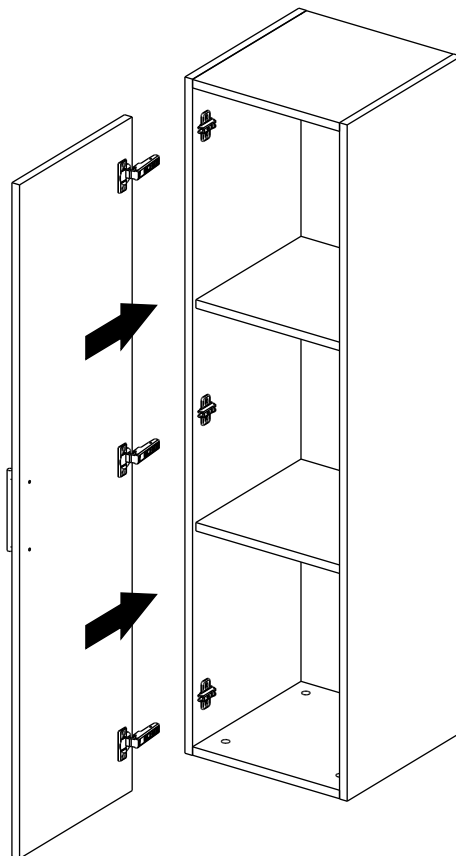
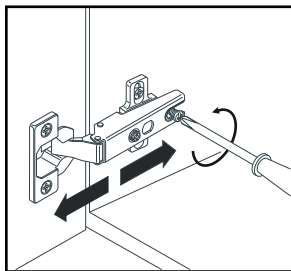
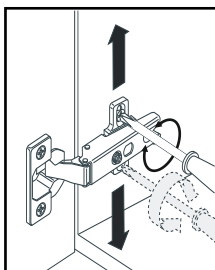
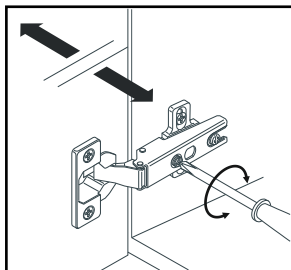

8



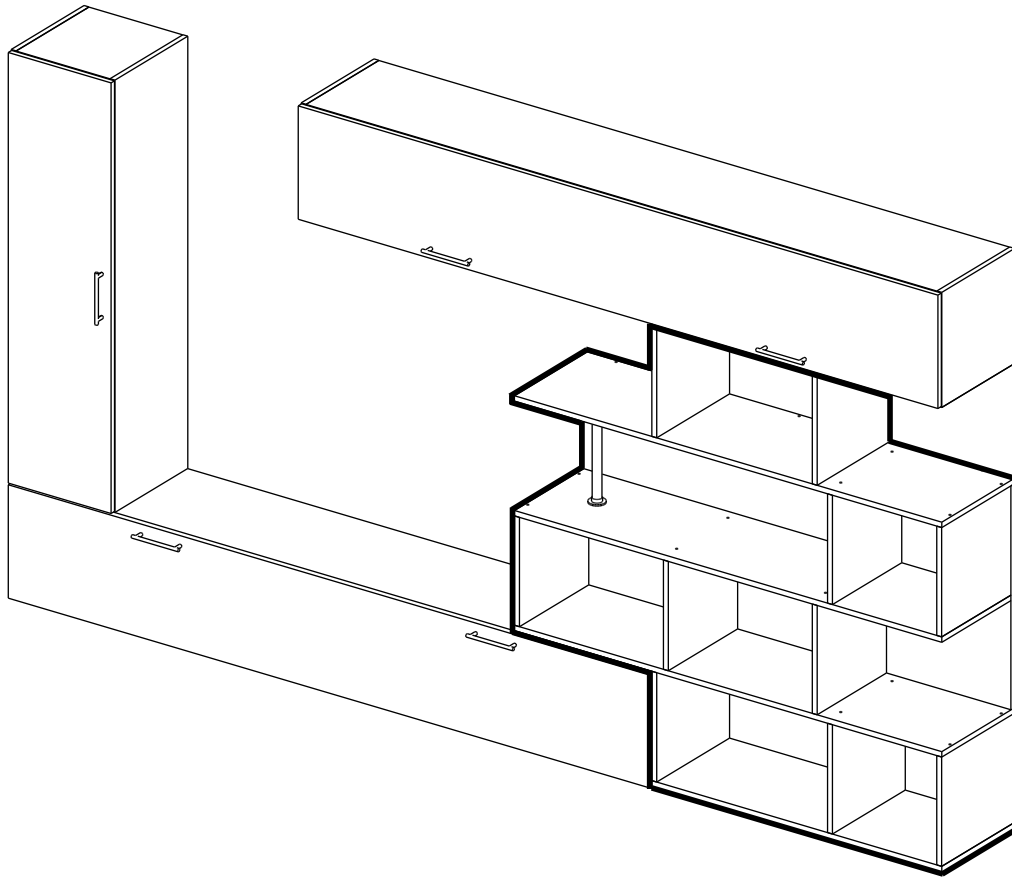

(1400)

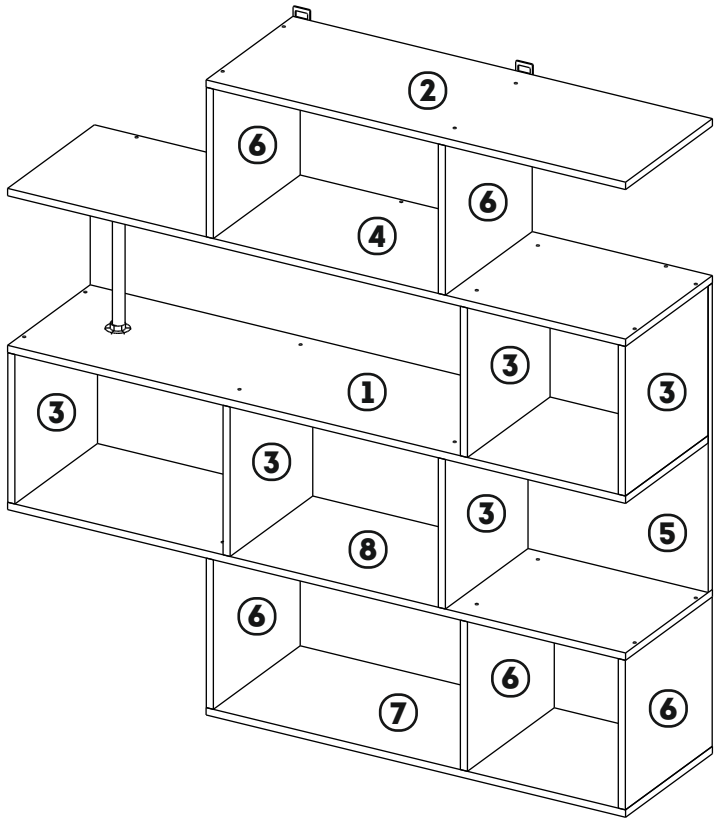

No	a*b	X
1	1400x324	1
2	950x340	1
3	324x324	5
4	1400x340	1
5	664x1400	1
6	324x340	5
7	950x340	1
8	1400x340	1

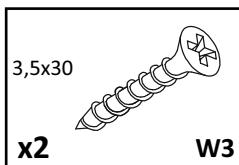
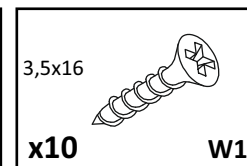
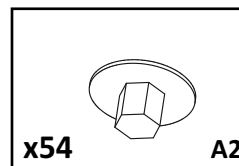
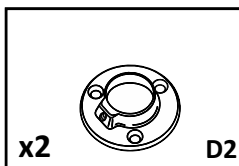
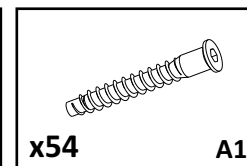
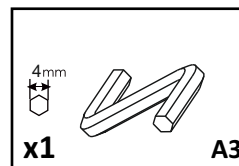
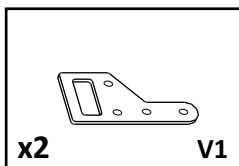

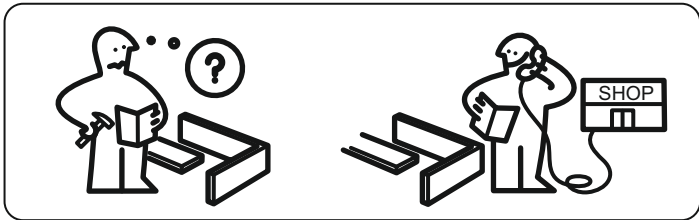
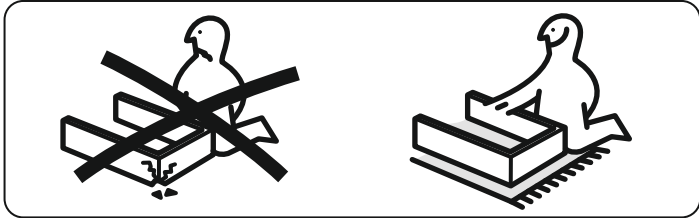
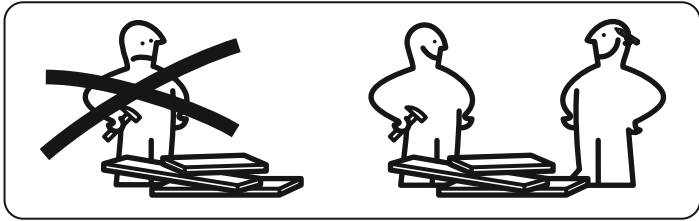

# 1

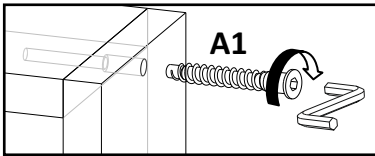
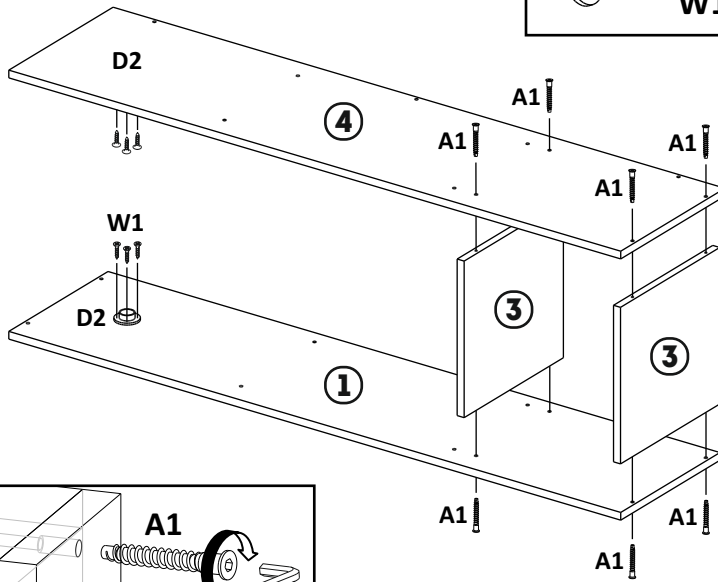
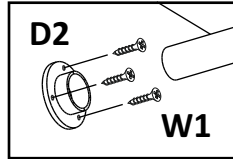
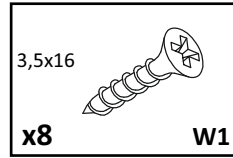
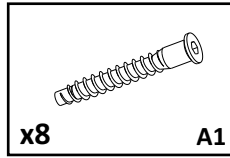
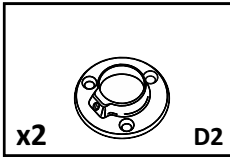

# 2

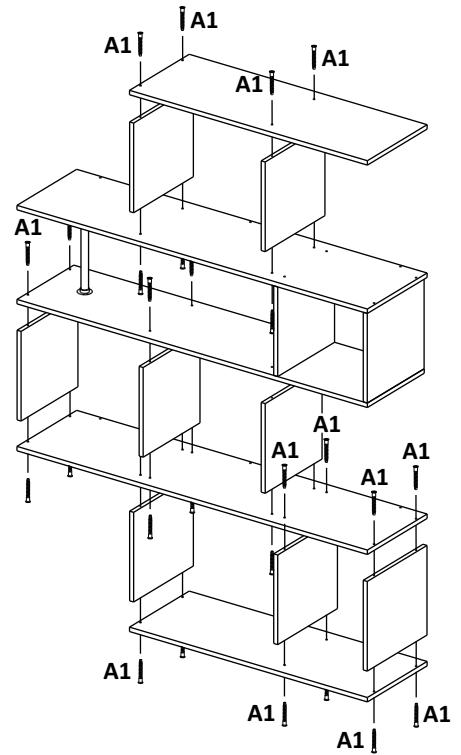
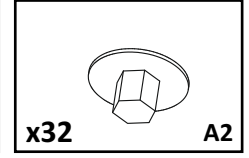
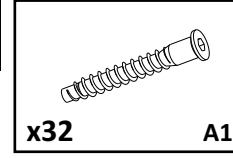

**3**

3,5x16

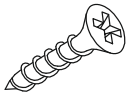

x6

W1

3,5x30

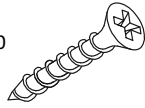

x2

W3

x14

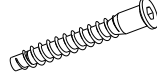

A1

x2



V1

W1 (x3)  
W3 (x1)

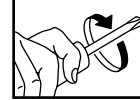

V1

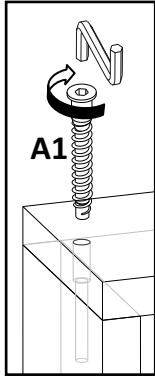

A1

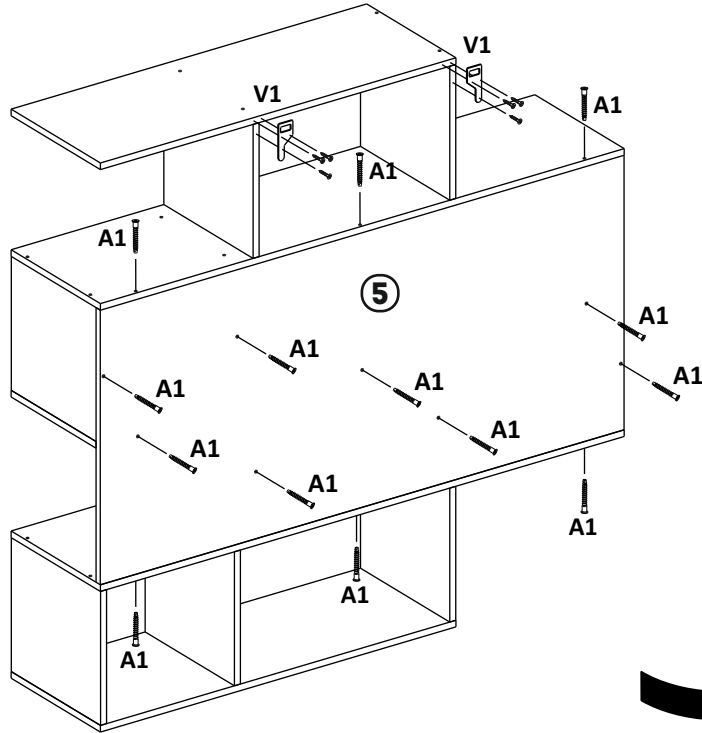
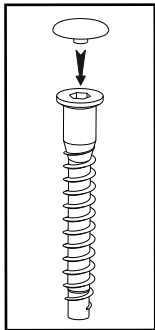

5

6

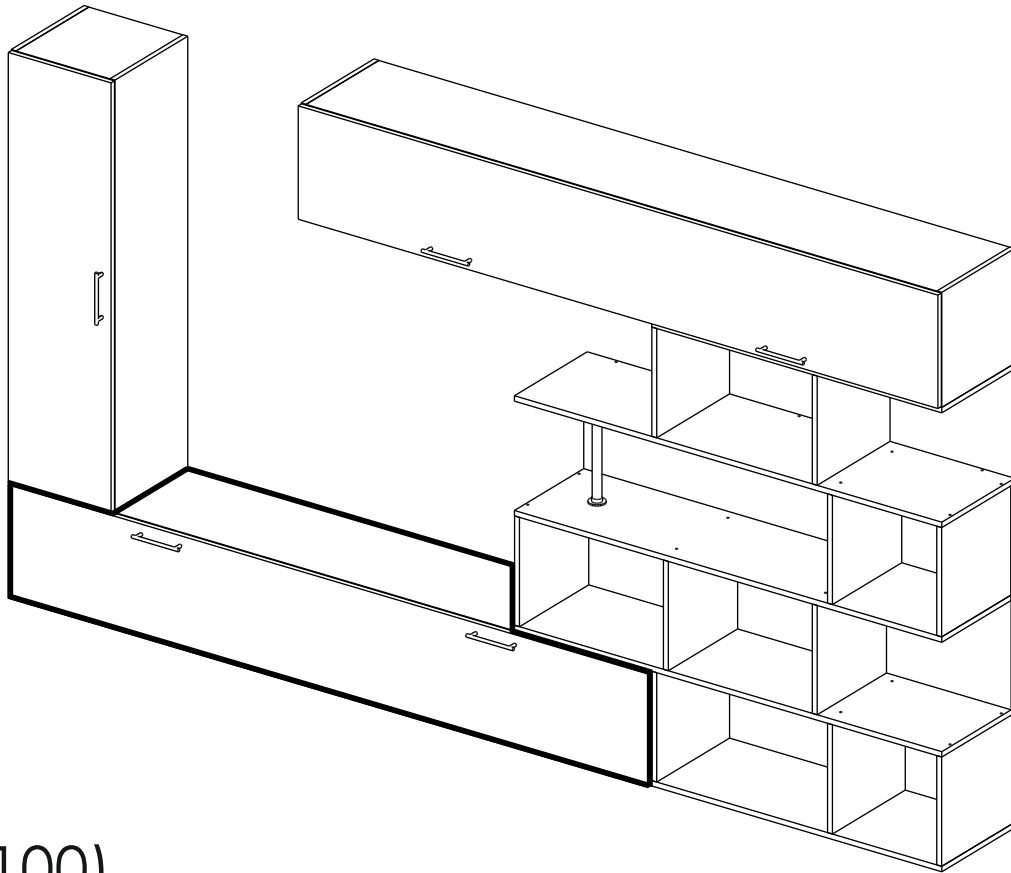

(2100)

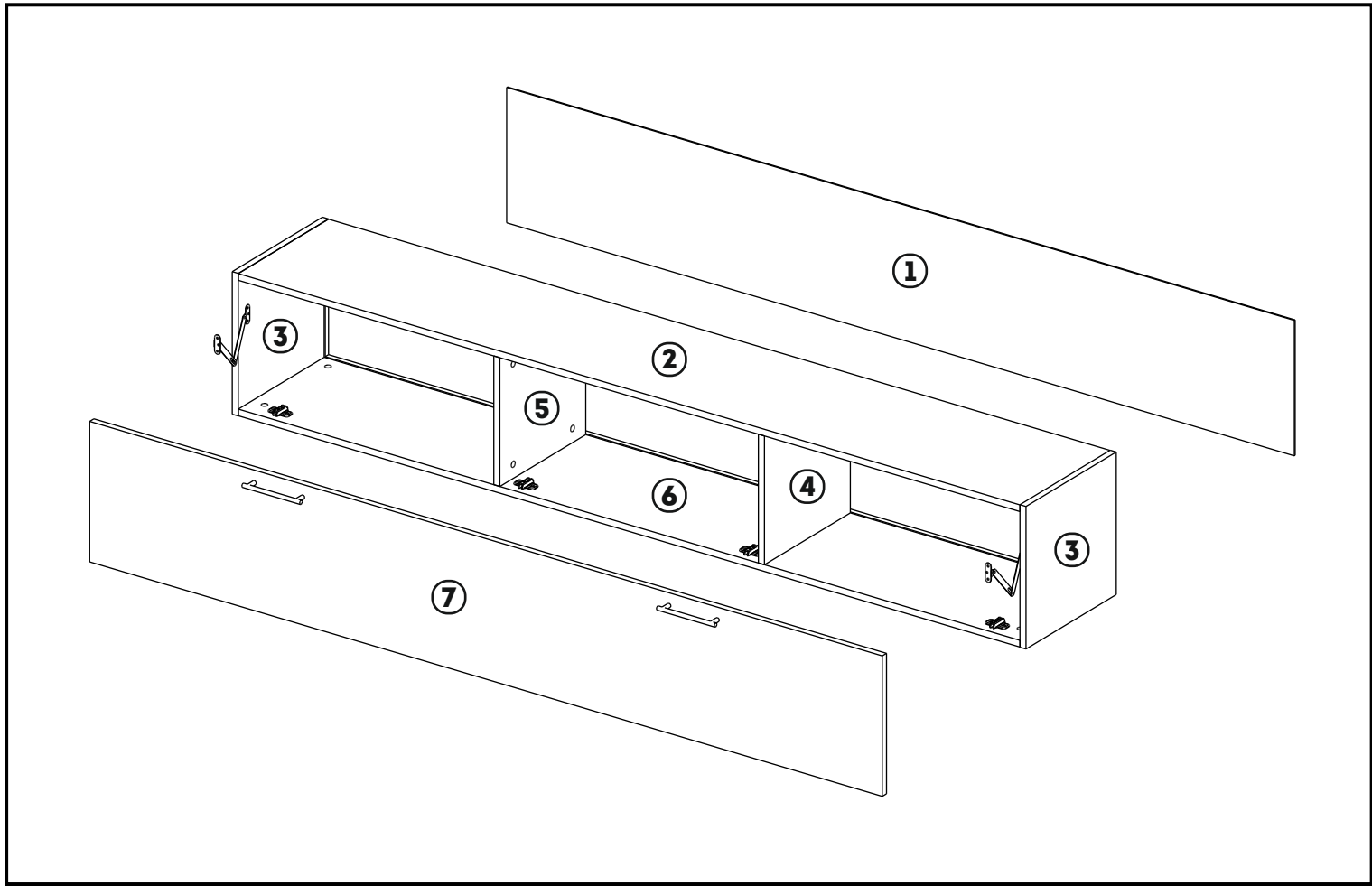



No	a*b	X
1	324x2084	1
2	2068x340	1
3	340x340	2
4	308x324	1
5	308x324	1
6	2068x340	1
7	336x2097	1

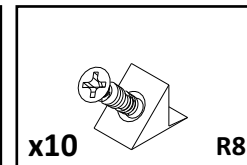
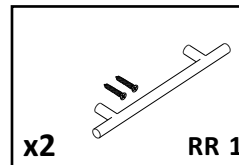
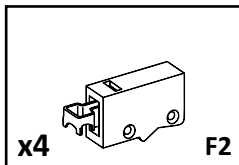
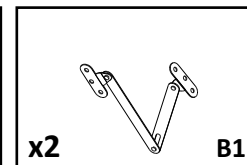
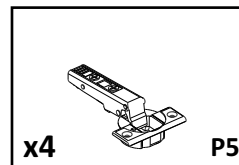
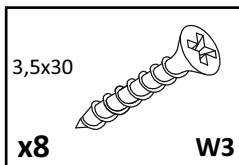
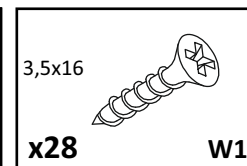
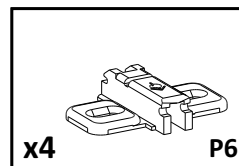
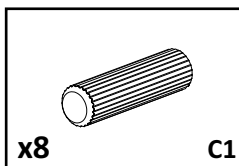
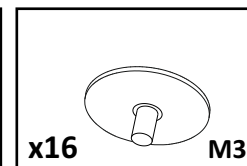
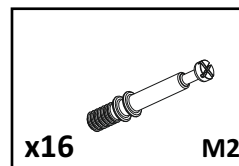
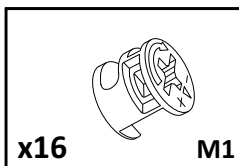

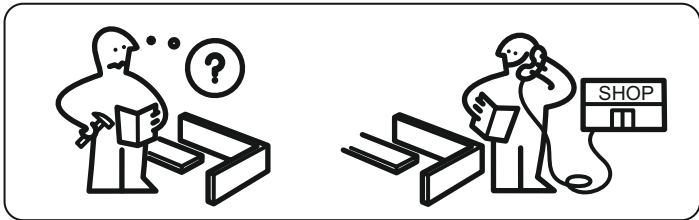
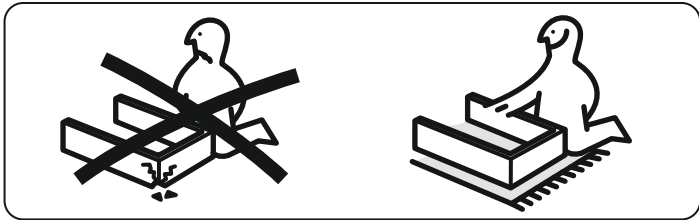
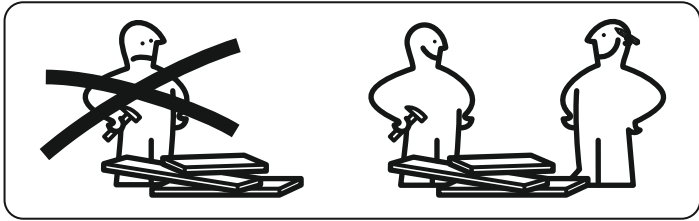

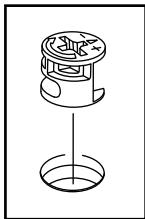
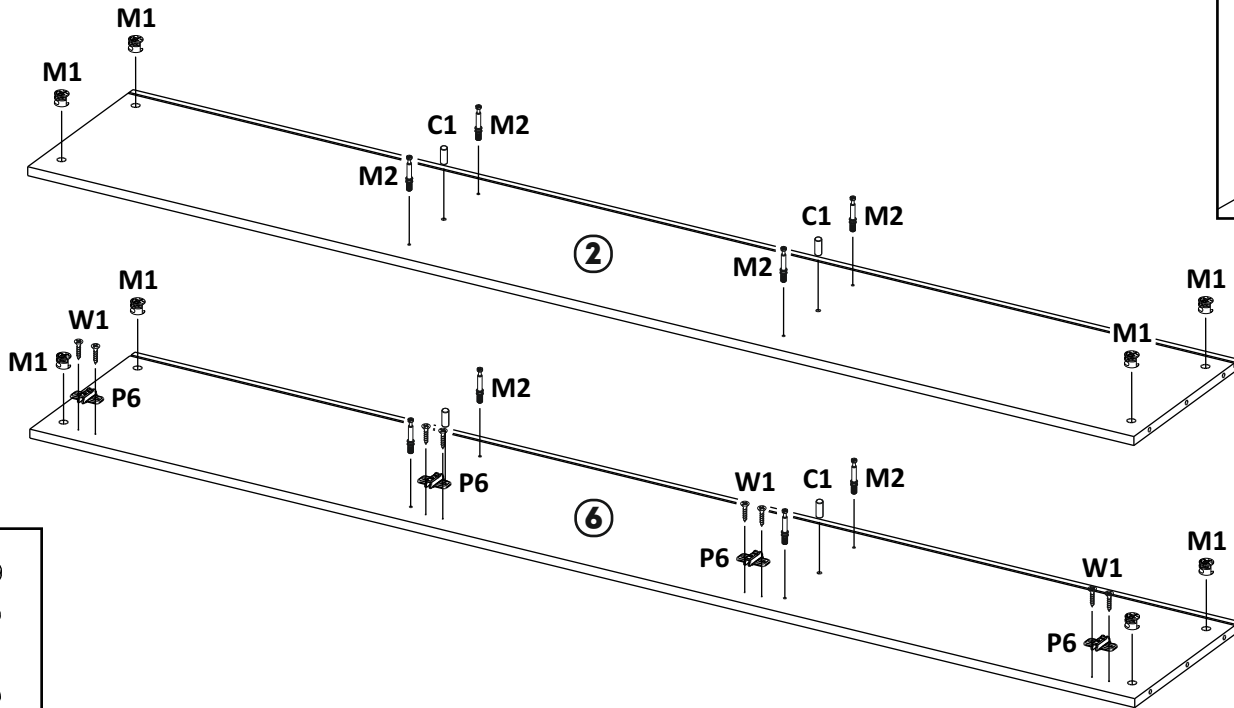
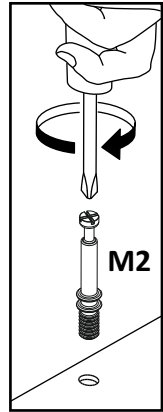
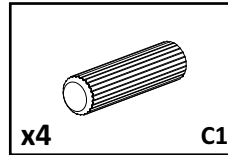
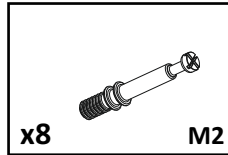
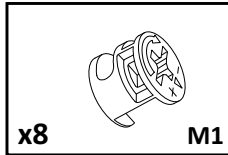
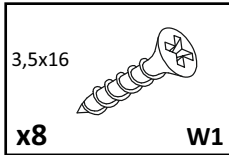
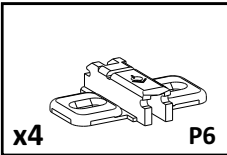
**1**

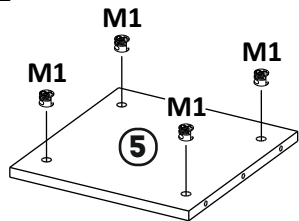
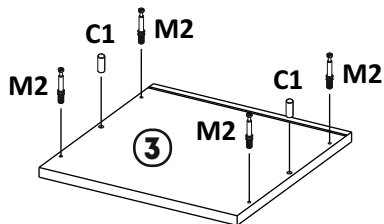
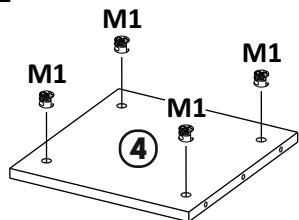
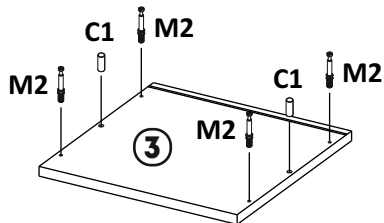
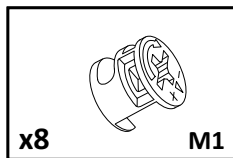
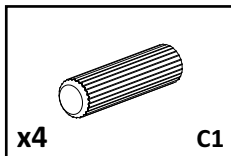
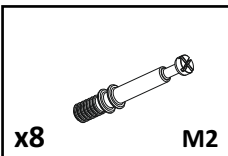
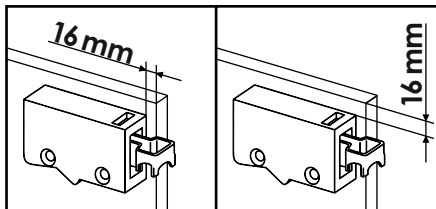
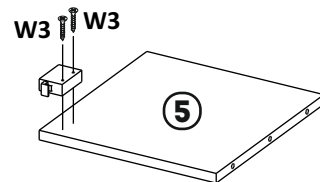
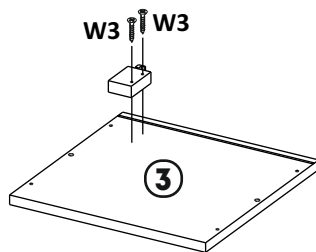
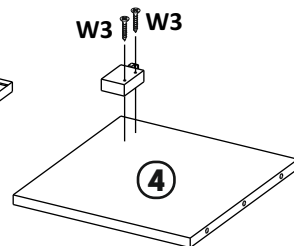
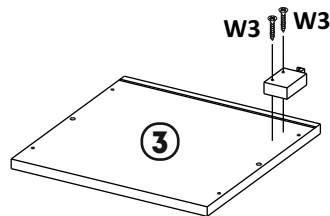
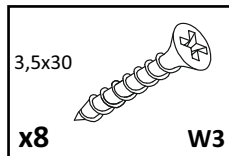
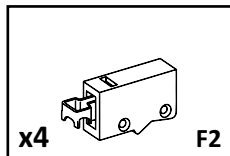
**2****3**

4

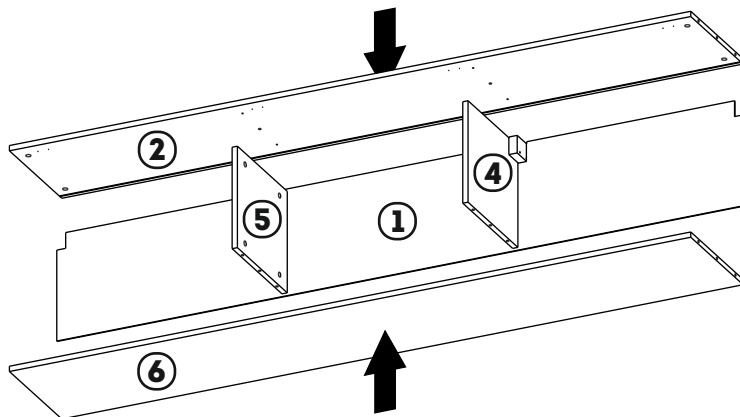
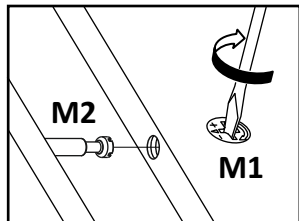

5

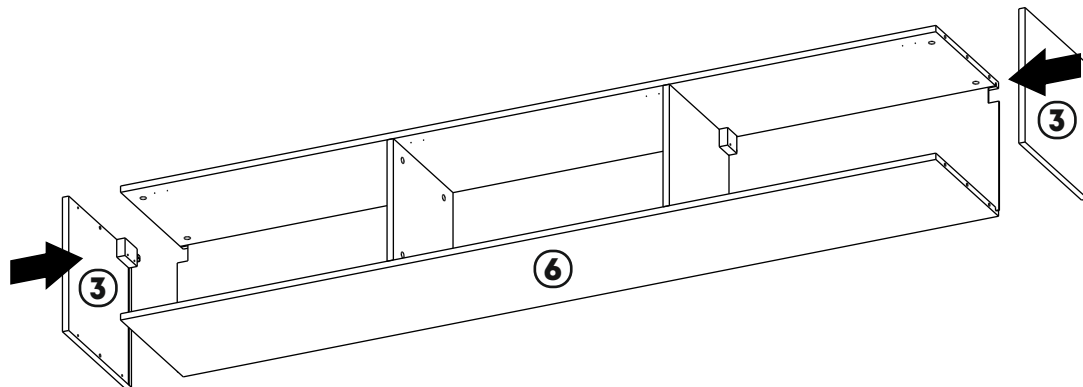

6

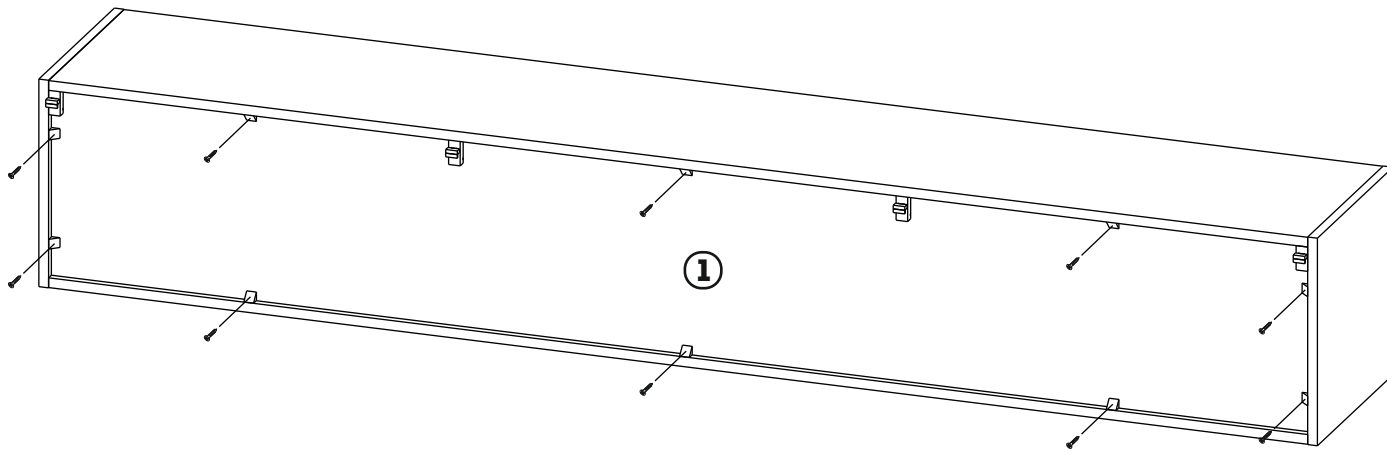
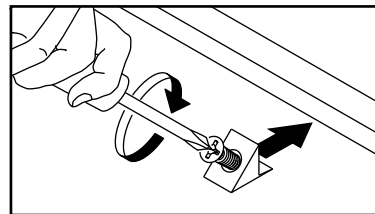
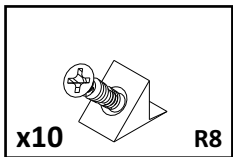

# 7

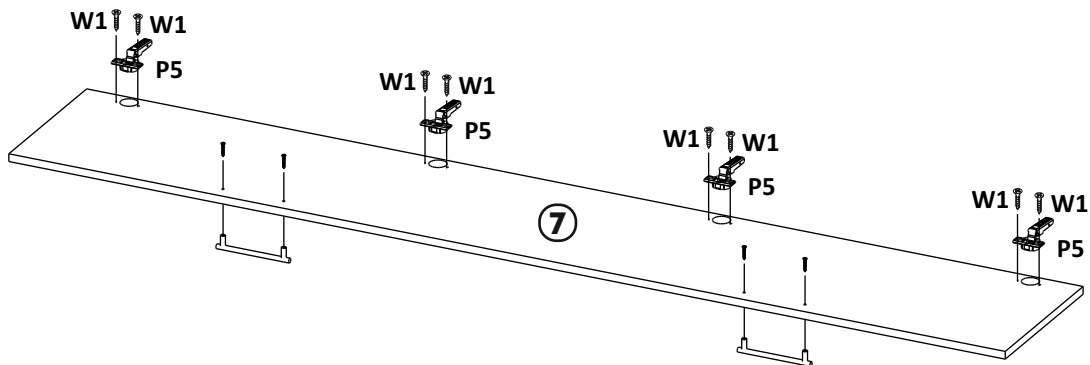
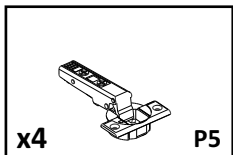
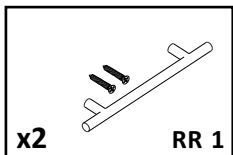

# 8

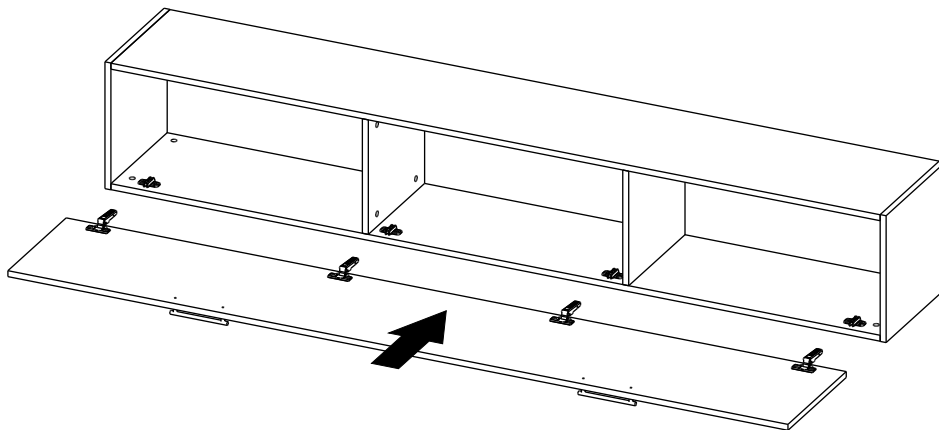
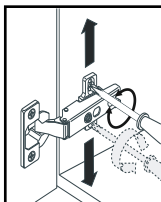
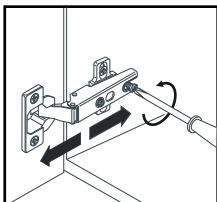
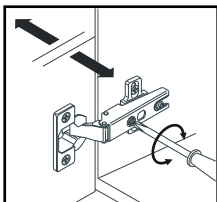

9

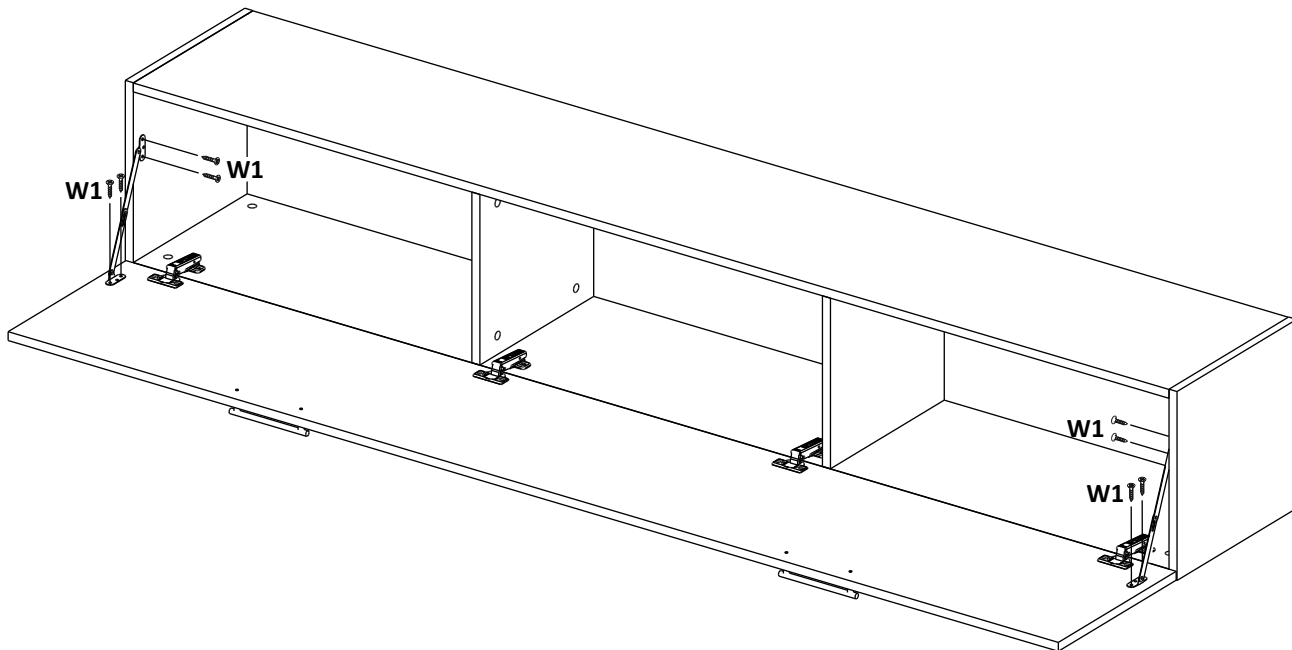
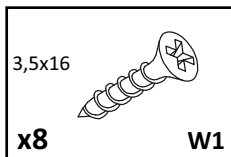
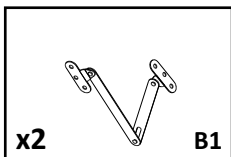



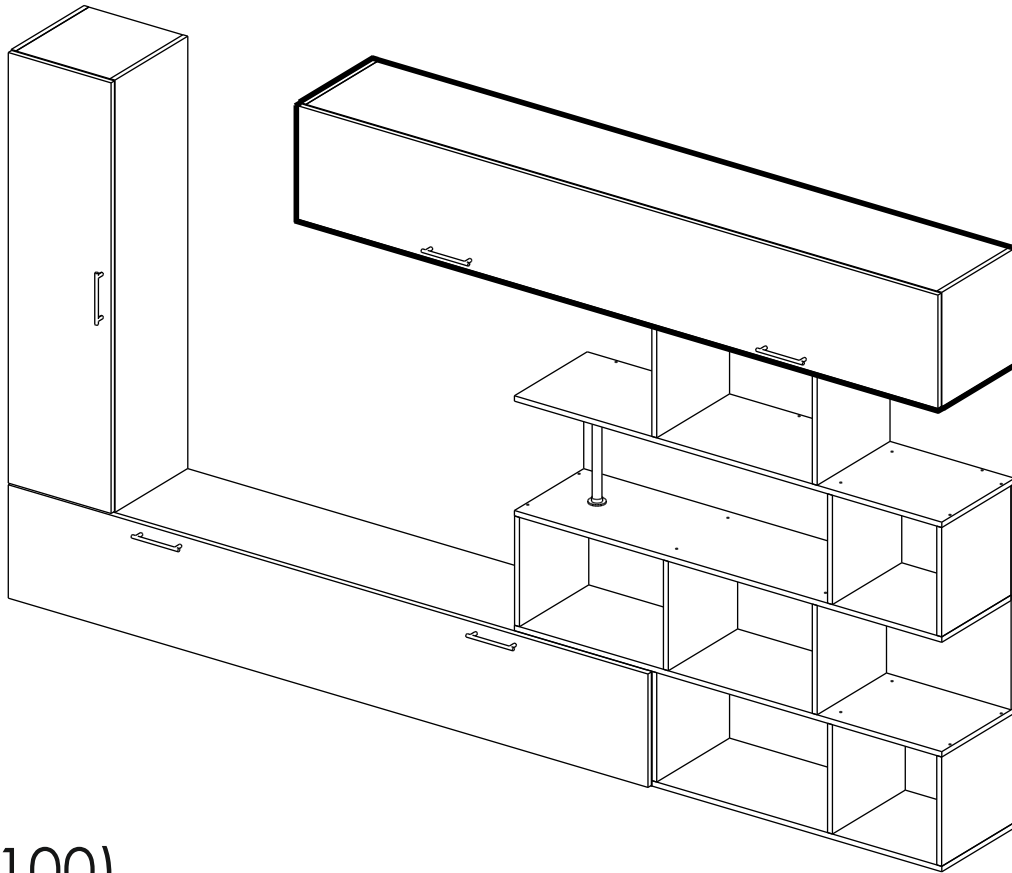

(2100)

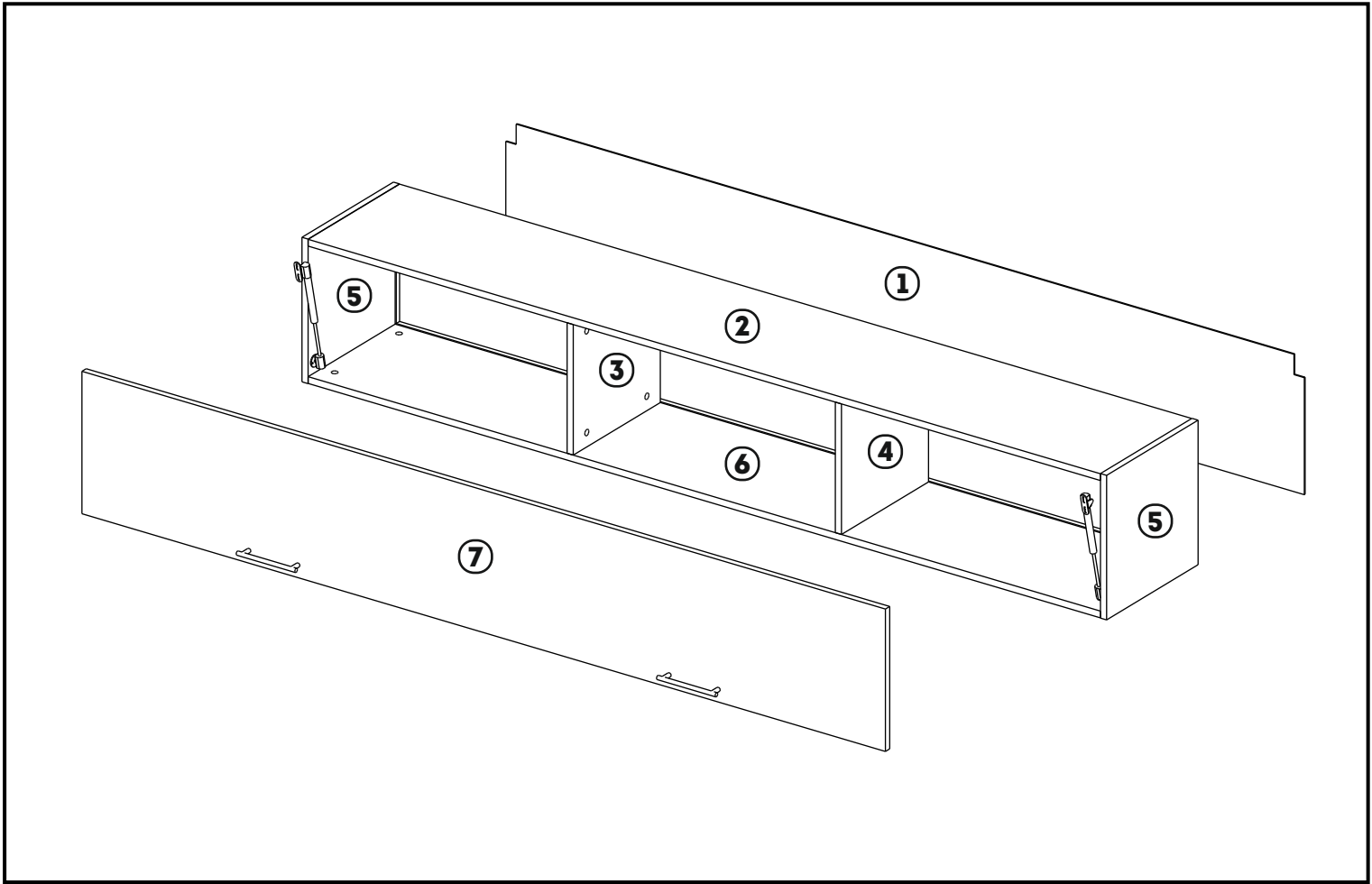

No	a*b	X
1	324x2084	1
2	2068x340	1
3	308x324	1
4	308x324	1
5	340x340	2
6	2068x340	1
7	336x2097	1

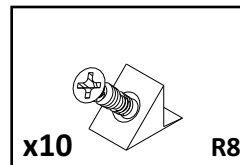
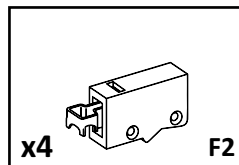
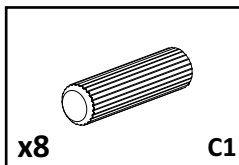
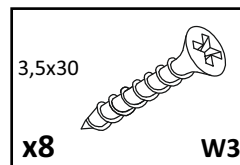
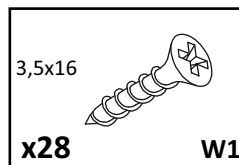
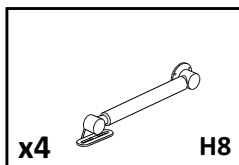
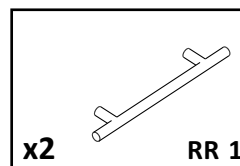
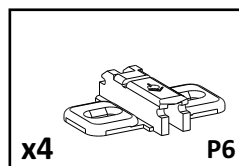
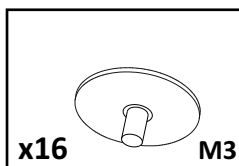
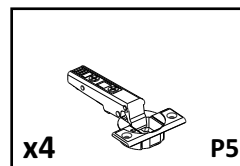
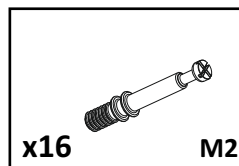
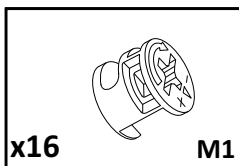

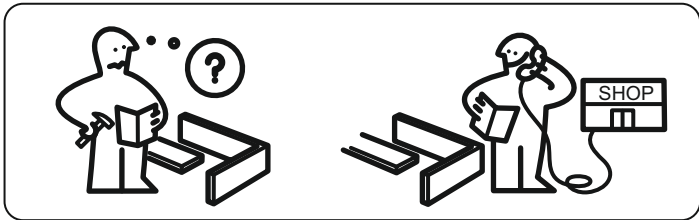
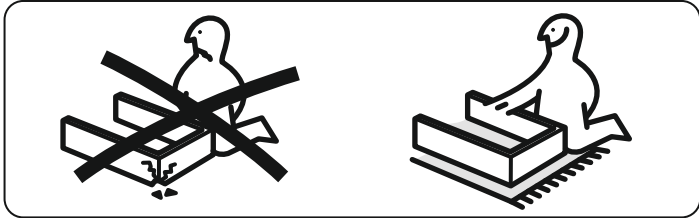
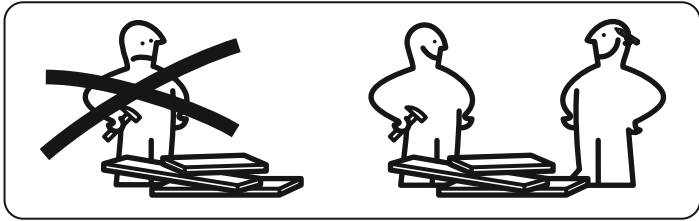

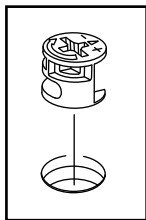
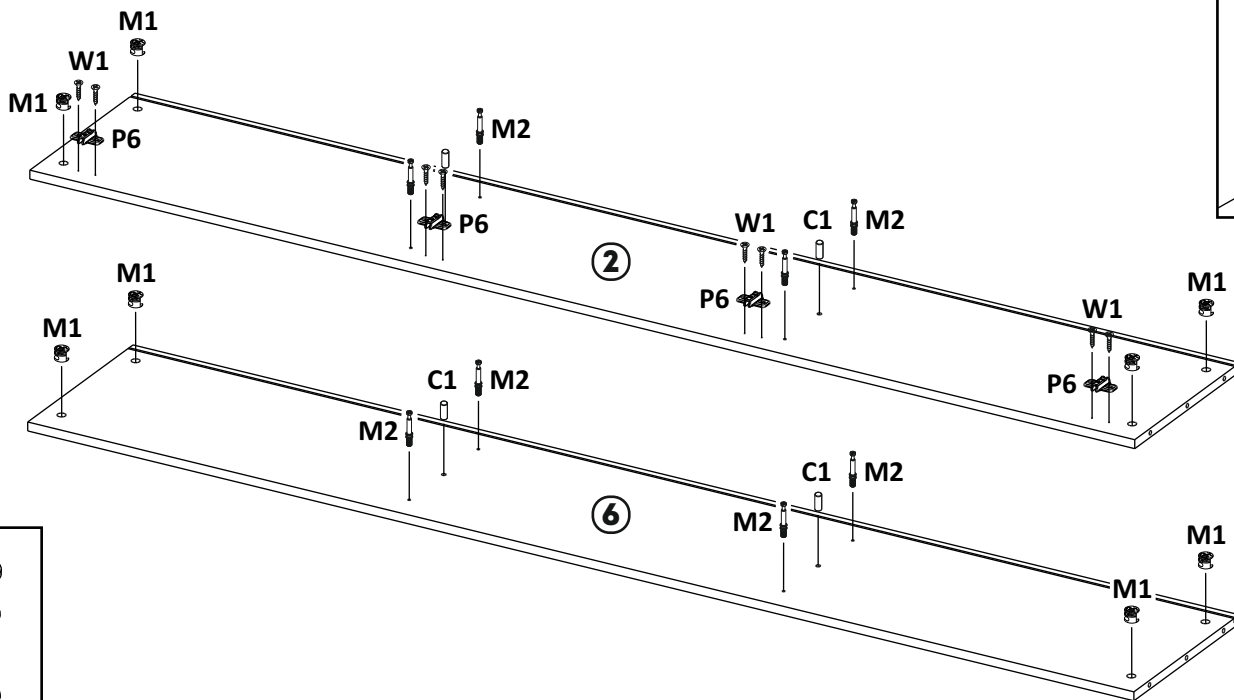
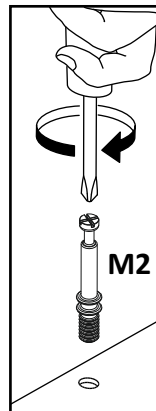
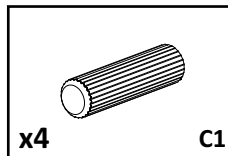
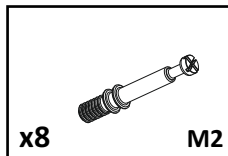
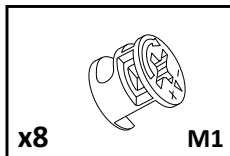
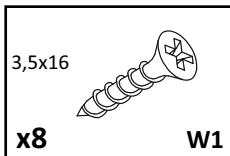
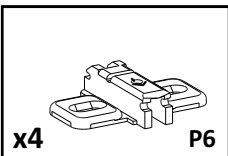
**1**

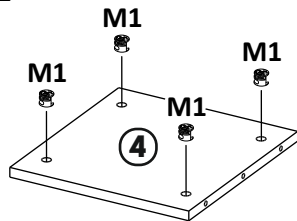
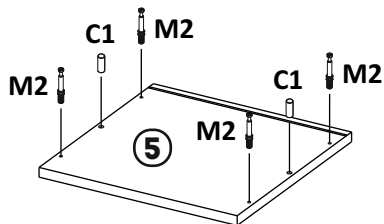
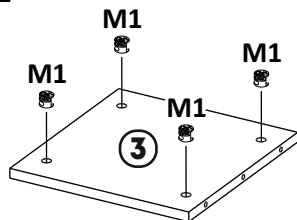
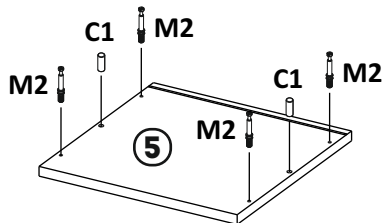
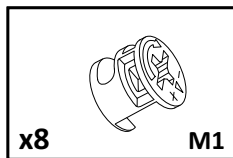
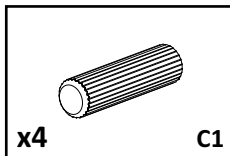
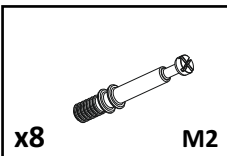
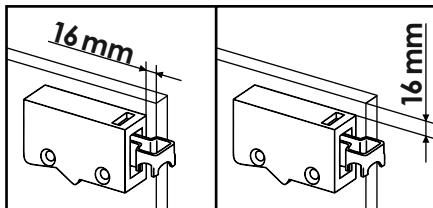
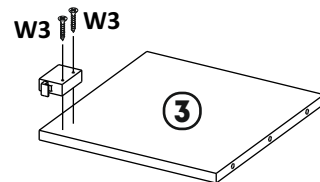
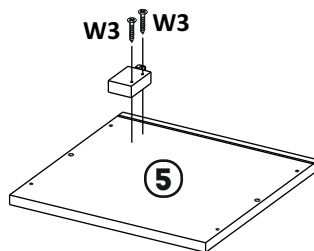
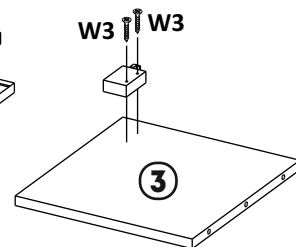
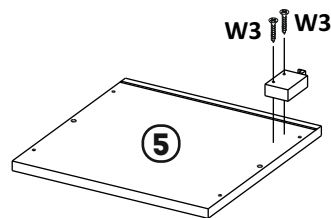
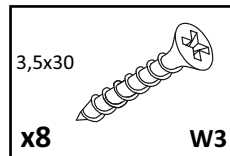
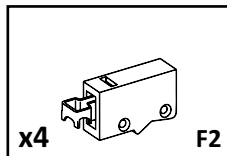
**2****3****6**

**4**

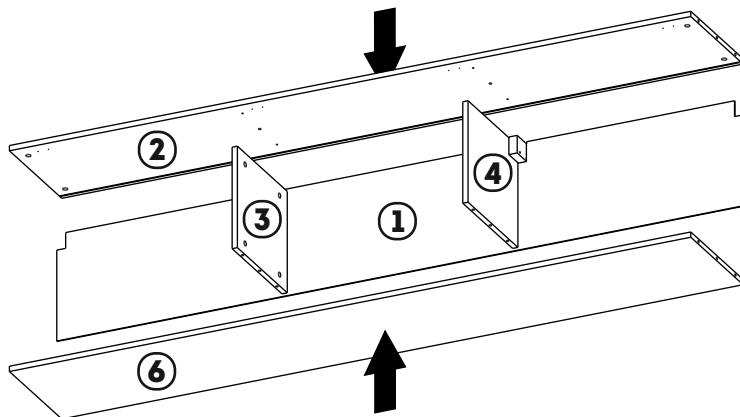
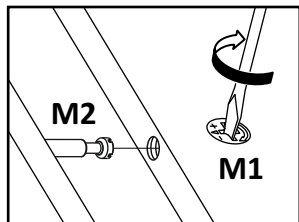

**5**

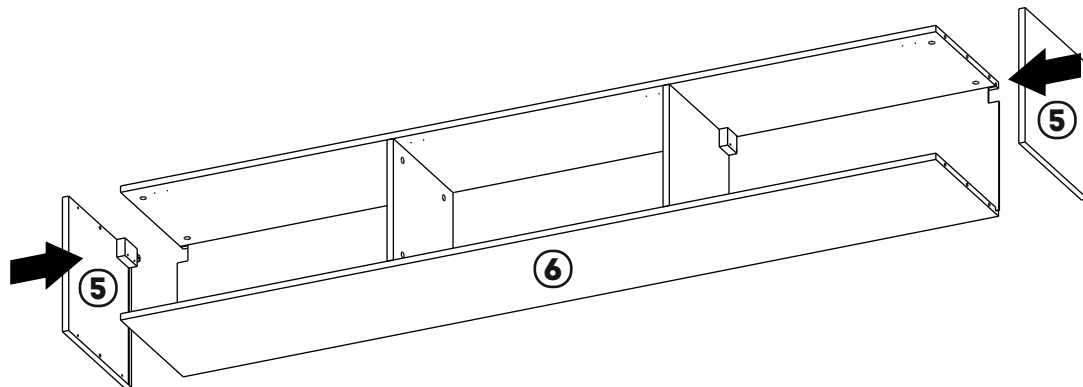

6

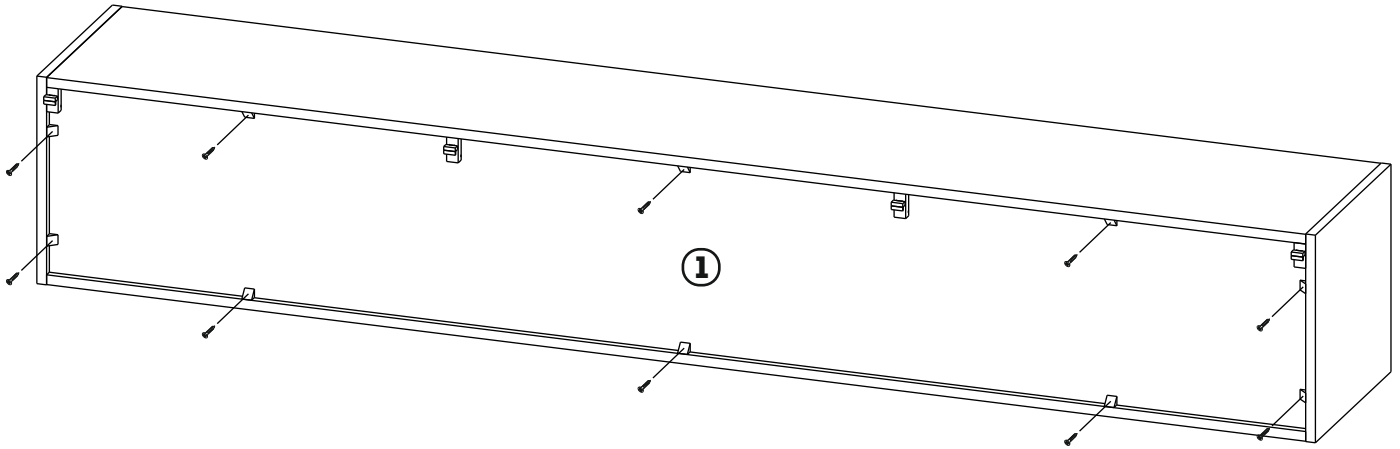
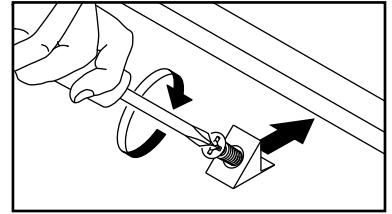
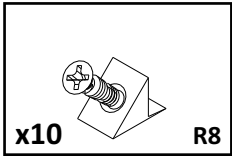



# 7

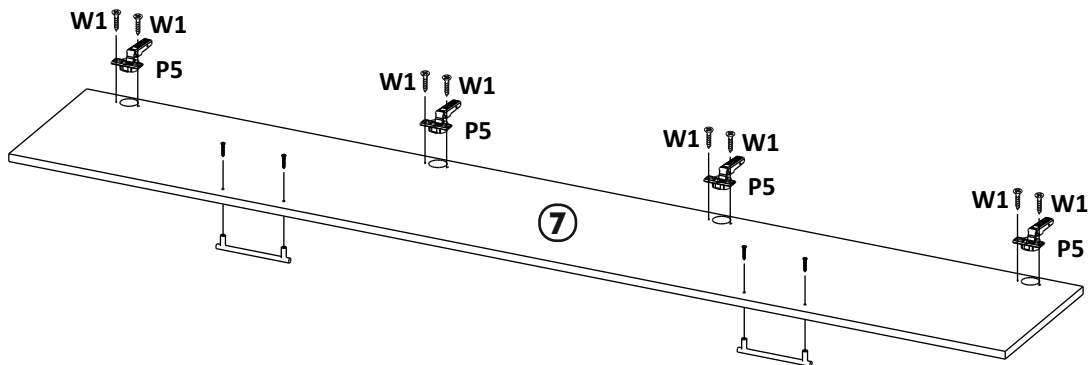
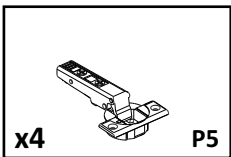
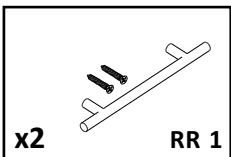

# 8

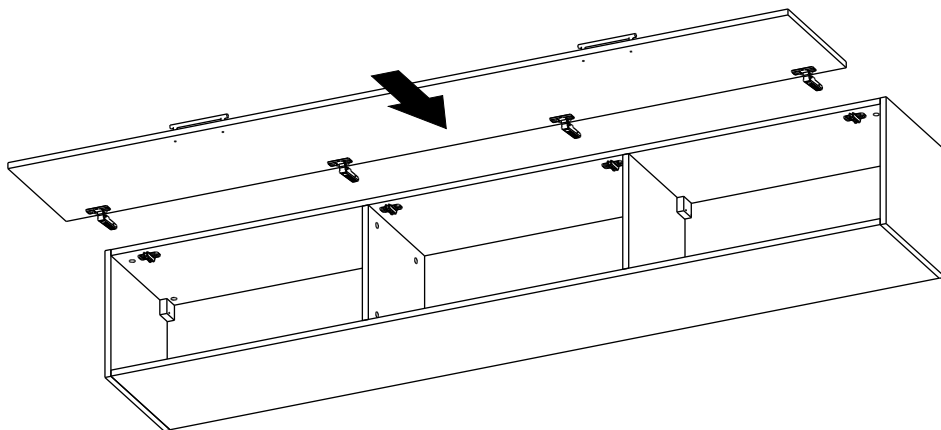
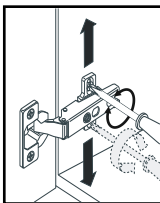
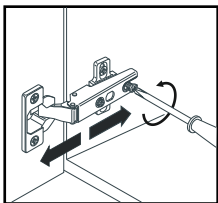
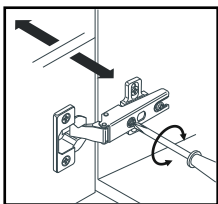

9

9

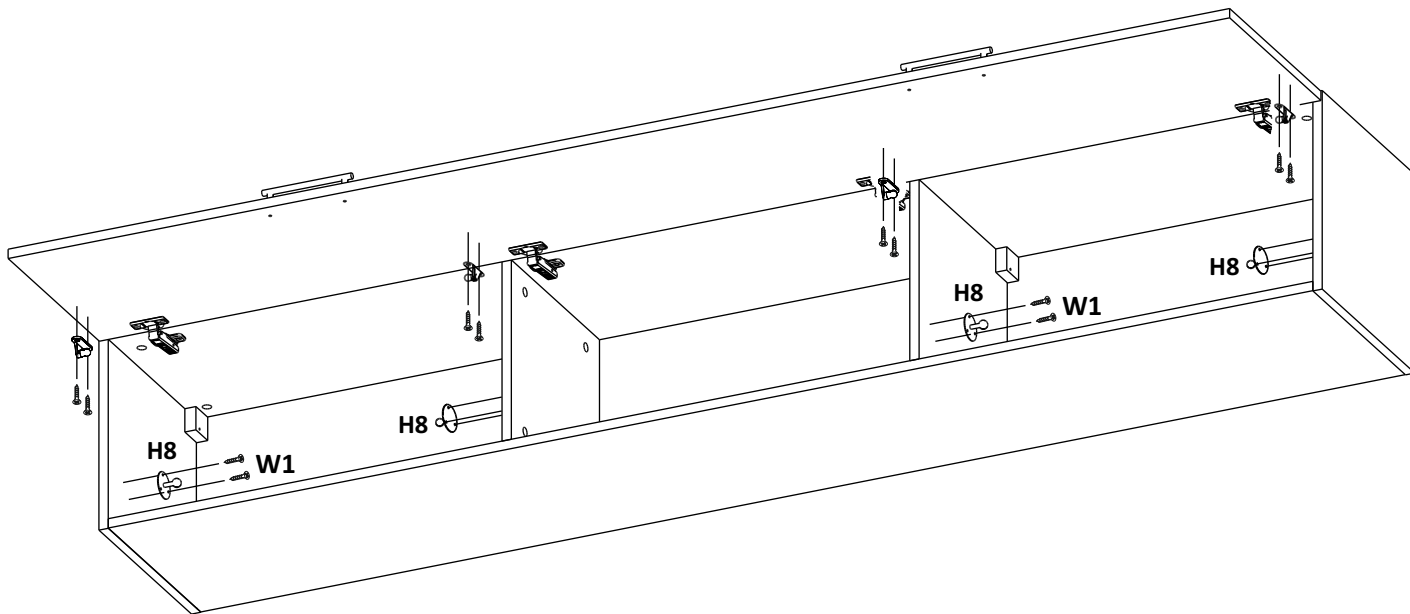
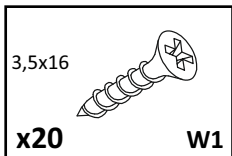
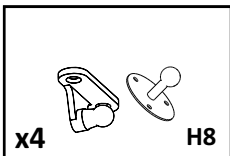

**10**

